

ACCESSORIES CATALOGUE 2015/16



Milwaukee®

Nothing but **HEAVY DUTY™**



Nothing but **HEAVY DUTY.**[™]



SHOCKWAVE
IMPACT DUTY 

THUNDERWEB

RX4

SPEEDCROSS

SAWZALL

Contents	Page No.
Abrasives	103–105
	– Coated – Abrasive Paper 98
	– Cutting and Grinding Discs 99
	– Flap Discs 99
Angle Grinder System Accessories / FIXTEC Nut	100–102
Band Saw Blades	134
Batteries & Chargers	142–143
Biscuit Jointer System Accessories	135
Caulk and Adhesive Gun System Accessories	140
Chisels & Special Application Tools	22–24
	– SDS-plus 25–26 / 29
	– SDS-Max 27–29
	– 21 mm K-Hex 80–81
	– Keyed & Keyless 79
	– Chuck Adaptors 79
Chucks	80–81
	– Chuck Adaptors 79
Circular Saw Blades/System Accessories	131–133
Cores/Tunnel Bits – TCT	12
	– SDS-plus 17–18
	– SDS-Max 19
	– SDS-Max Vario Extension System 90–97
Diamond Blades/Diamond Cup Wheels	90–97
Diamond Core Bits	82–84
	– Wet Core Bits/System Accessories 85–89
	– Dry Core Bits/System Accessories 7–10
Drill Bits ■ Concrete	7–10
	– SDS-plus MS2 4–6
	– SDS-plus RX4 11
	– SDS-plus Contractor & Multipurpose 15–16
	– SDS-Max 18
	– 21 mm K-Hex 31
■ Concrete/Masonry (round shank)	32
	– Concrete 31
	– Concrete Super 32
■ Multi Material	33
	– Multi Material 34
■ Wood	34
	– Auger Impact Rated 36
	– Auger 42
	– Cable 41
	– Flat Boring 37
	– Forstner/TCT Forstner 40
	– Lip & Spur 37
■ Selffeed Bits	38
	– Switchblade™ Selffeed 39
	– Selffeed 42
	– Speed Feed™ 42
■ Glass & Tile	33
	– Glass & Tile 56
■ Metal	56
	– HSS Annular Cutters 52–53
	– HSS-G-Cobalt DIN 338 50–51 / 76
	– HSS-Ground DIN 1897/Double Ended/DIN 340 48–50
	– HSS-Ground THUNDERWEB 46–47
	– HSS-Rollforged 54
■ Contractor Sets	54
	– 50/100 pcs Sets 20–21
Drill Connect	20–21
Drilling System Accessories	66
	– QUIK-LOK Cables/Side Handles/Right Angle Drill 66/141
Dust Absorption System Accessories	66/141
Expander Heads	135
Grease	11
HACKZALL Blades	123
Heated Jacket System Accessories	138
Handtools	157
	– INKZALL Markers 154
	– Jobsite Scissors 148–159
	– Knives/Blades 150
	– Metal Snips 154
	– Plastic/PEX Cutter 150–153
	– Pliers 153
	– Stop Lock Clamps 158–160
	– Storage Solutions – Workboxes & Softside 155–156
	– Tape Measures 58–63
Holesaws	58–63
	– Bi-Metal Hole Dozer™ 64
	– Diamond Plus™ 13–14
	– Universal TCT 65
	– Shockwave Impact Holesaws 78
Impact Wrenches System Accessories	78
Inspection Camera System Accessories	138
Jigsaw Blades/System Accessories	124–130
Jobsite Work Box	158
Lamps and Bulbs	142
Magswitch™	144–145
Magnetic Drill Stand/System Accessories	57
Nibbler System Accessories	137
Pipe Cutter/Cable Cutter System Accessories	137
Planer Accessories	133
Plate Shear System Accessories	136
Polishing Accessories	108–109
Press Jaws	139
Router System Accessories	135
Sanding System Accessories	107
	– Belt Sanders 107
	– Delta Sanders 107
	– Orbital Sanders 107
	– Random Orbital Sanders 106
SAWZALL® Blades/System Accessories	110–122
Screwdriving System Accessories	78
Screwdriving	67–68
	– Screwdriving Bits 69–73
	– Shockwave Bits/Sets 75
	– Shockwave Magnetic Nut Drivers 75
	– Shockwave Magnetic Bit Holder/Adaptors 76
	– Shockwave Metal Drill Bits HSS-Ground 76
	– Offset Attachment Knuckle™ 77
	– Offset Attachment OSD 2 74
	– Shockwave Sockets ½" / ¼" 146–147
Stiletto® Titanium Tools	146–147
Stone Saw Blades	137
Straight Die Grinders System Accessories	136
Test & Measure System Accessories	137
Transport Cases	138



LONGER THAN LIFE!

+ 50% LONGER LIFE TIME



Thanks to the optimum 4x90° symmetry, all four carbide cutting edges function evenly and do not jam up when hitting rebar.



Solid one piece carbide tip for outstanding lifetime.



Centering tip for straight forward spot drilling with pinpoint accuracy.



Four symmetrically spiral shoulders ensure low, uniform flute wear.

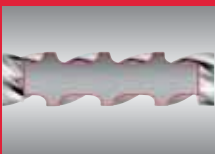

Thicker core body for low vibration and extra strength minimising drill bit breakages.



The PGM seal guarantees precisely fitting anchor application holes over the entire lifetime of the drill bit.



SDS-plus RX4 drill bits - 4 cut



Embedded solid one piece carbide with centering tip for easy spot drilling and long lifetime.

Four symmetrical 90° cutting edges guarantee perfect round holes for anchor fixing as well as reduce the risk of the drill bit jamming when hitting rebar. The high volume flute geometry ensures optimum dust removal.

4 spiral flute design provides lowest vibration and low uniform flute wear.

Suitable for brick, concrete, reinforced concrete and natural stone.

Diameters >Ø 18 mm have a 3pc carbide tip.

Made in Germany.

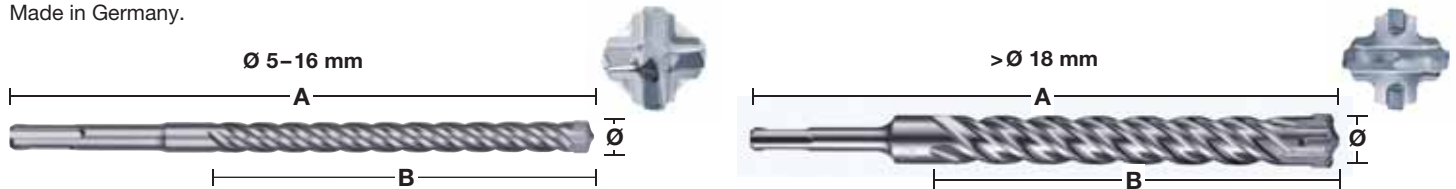
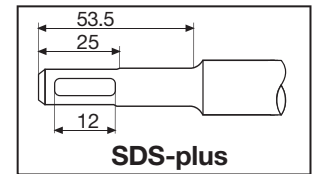

Ø mm	A mm	B mm	Quantity	Id. No. 4932	EAN Code 4002395
5	110	50	1	352007	366644
5	160	100	1	352008	368891
5	260	200	1	430724	383856
5.5	110	50	1	352009	368907
5.5	160	100	1	352010	368914
6	110	50	1	352011	368921
6	160	100	1	352012	368938
6	210	150	1	352013	366705
6	260	200	1	352014	366712
6	310	250	1	352015	366729
6.5	160	100	1	430146	378074
6.5	210	150	1	352016	366736
6.5	260	200	1	352017	366743
6.5	310	250	1	352018	366750
7	110	50	1	352019	366767
7	160	100	1	352020	366774
8	110	50	1	352021	366781
8	160	100	1	352022	366798
8	210	150	1	352023	366804
8	260	200	1	352024	366811
8	310	250	1	352712	373703
8	450	400 ▲	1	352713	373710
9	160	100	1	352944	376025
9	260	200	1	430409	380701
10	110	50	1	352025	366828
10	160	100	1	352026	366835
10	210	150	1	352027	366842
10	260	200	1	352028	366859
10	310	250	1	352029	366866
10	450	400 ▲	1	352030	366873
10	600	540 ▲	1	352945	376032
10	1000	940 ▲	1	352946	376049
12	160	100	1	352031	366880
12	210	150	1	352032	366897
12	260	200	1	352033	366903
12	310	250	1	352034	366910
12	450	400 ▲	1	352035	366927
12	600	540 ▲	1	352947	376056
12	1000	940 ▲	1	352948	376063
14	160	100	1	352036	366934
14	210	150	1	352037	366941
14	260	200	1	352949	376070
14	310	250	1	352038	366958
14	450	400 ▲	1	352039	366965
14	600	540 ▲	1	352950	376087
14	1000	940 ▲	1	352951	376094
15	160	100	1	430725	383863
15	260	200	1	352952	376100
16	160	100	1	430726	383870
16	210	150	1	352953	376117

▲ Pre-drill with a short drill bit of the same diameter.

SDS-plus RX4 drill bits - 4 cut



▲ Pre-drill with a short drill bit of the same diameter.

Ø mm	A mm	B mm	Quantity	Id. No. 4932	EAN Code 4002395
16	260	200 ▲	1	352819	374779
16	310	250	1	352954	376124
16	450	400	1	352820	374786
16	600	540 ▲	1	352955	376131
16	1000	940 ▲	1	352956	376148
18	250	200	1	356502	320950
18	450	400	1	356503	320967
20	250	200	1	356504	320974
20	450	400 ▲	1	356505	320981
22	250	200	1	399332	359608
22	450	400 ▲	1	356506	320998
24	250	200	1	356507	321001
24	450	400 ▲	1	356508	321018
25	250	200	1	399333	359615
25	450	400 ▲	1	356509	321025
28	250	200	1	399334	359622
28	450	400 ▲	1	356510	321032
30	250	200	1	399335	359639
30	450	400 ▲	1	356511	321049
32	450	400 ▲	1	399336	359646

SDS-plus RX4 drill bits - 4 cut/10 pack



Ø mm	A mm	B mm	Quantity	Id. No. 4932	EAN Code 4002395
5	110	50	10	352040	366972
5.5	160	100	10	352041	366989
6	110	50	10	352042	366996
6	160	100	10	352043	367009
6	210	150	10	430234	378951
6.5	210	150	10	430235	378968
7	160	100	10	352044	367016
8	110	50	10	352045	367023
8	160	100	10	352046	367030
10	160	100	10	352047	367047
10	210	150	10	352048	367054
12	160	100	10	352049	367061
12	210	150	10	352050	367078

SDS-plus RX4 drill bits - 4 cut/50 pack



Ø mm	A mm	B mm	Quantity	Id. No. 4932	EAN Code 4002395
6	110	50	50	430437	380985
6	160	100	50	430438	380992
6	210	150	50	430462	381234
6.5	210	150	50	430463	381241
8	160	100	50	430439	381005
8	210	150	50	430440	381012
10	160	150	50	430441	381029
10	210	150	50	430442	381036
12	210	150	50	430443	381043

SDS-plus RX4 drill bits - 4 cut/cassettes



Description	Quantity	Id. No. 4932	EAN Code 4002395
SDS-plus drill bit set (5-piece). Plastic container			
① with Ø 5/6x110 mm	1	352833	374915
with Ø 6/8/10x160 mm.			
SDS-plus drill bit set (5-piece). Plastic container			
① with Ø 5.5x110 mm	1	352835	374939
with Ø 5.5/6/7/8x160 mm.			
SDS-plus drill bit set (7-piece). Plastic cassette			
② with Ø 5/6/8x110 mm	1	352051	367085
with Ø 6/8/10/12x160 mm.			
Counter display			
③ (contains 6x 7pc SDS-plus RX4 set 4932352051)	1	352153	368068





FASTER THAN EVER

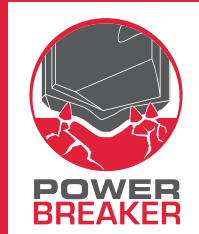

Power Breakers

- 3 offset aggressive power breakers. These produce a “Demolition” effect and create micro cracks in the drilled material
- **+25% FASTER**



Centering tip

- Ensures immediate spot drilling with pin point accuracy
- Prevents skidding on smooth surfaces



Enlarged rebar chamfers

- Enlarged rebar chamfers
- Prevents side tip damage when hitting rebar
- Reduces the risk of the drill bit jamming when hitting rebar



Tapered shoulder design

- Thinner shoulder towards drill tip for less friction providing for greater speed
- Ideal for cordless hammers identified from its tapered shoulder geometry



Reinforced flute

- High volume flute geometry for optimum dust removal
- Reinforced flute design (thicker core) gives:
 - Full power transfer to the tip
 - Lower vibrations
 - Exceptional break resistance, less breakages and best durability

+25% FASTER

SDS-plus MS2 drill bits - 2 cut



FASTEST:

New aggressive tip geometry with 3 chip breakers demolishes the concrete quicker and a tapered shoulder design minimises friction enabling the MS2 drill bit to deliver faster drilling speed.

DURABILITY:

Rebar chamfers on the tip prevent side tip damage when hitting metal reinforcement and a thicker core body ensures higher power transfer, lower vibrations and less flute breakages.

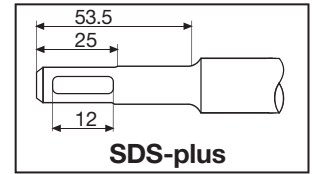

Made in Germany.

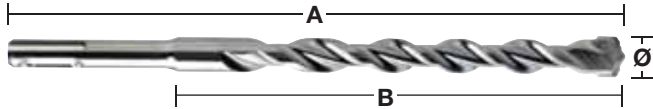

Ø mm	A mm	B mm		Quantity	Id. No. 4932	EAN Code 4002395
3	110	50		1	352892	375509
3.5	110	50		1	373908	353378
4	110	50		1	339498	304561
4	160	100		1	399143	357505
4.8	110	50		1	352130	367832
5	110	50		1	307067	308835
5	160	100		1	399315	359431
5	210	150		1	399316	359448
5.5	110	50		1	339499	304578
5.5	160	100		1	340408	311910
5.5	210	150		1	399317	359455
5.5	260	200		1	399318	359462
5.5	310	250		1	399319	359479
5.5	410	350		1	399320	359486
6	110	50		1	307068	308842
6	160	100		1	307069	308859
6	210	150		1	373136	346394
6	260	200		1	353819	320127
6	310	250		1	399321	359493
6	460	400	▲	1	399322	359509
6.5	110	50		1	344292	312276
6.5	160	100		1	344293	312269
6.5	210	150		1	399147	357574
6.5	260	200		1	399148	357581
6.5	310	260		1	399323	359516
7	110	50		1	353820	320134
7	160	100		1	340409	311927
7	210	150		1	399222	358366
7	250	200		1	399324	359523
8	110	50		1	307070	308866
8	160	100		1	307071	308873
8	210	150		1	307072	308880
8	260	200		1	353821	320141
8	310	250		1	399325	359530
8	400	350		1	399326	359547
8	460	400	▲	1	367013	336692
8	600	550	▲	1	399327	359554
8	1000	950	▲	1	399328	359561
9	160	100		1	353823	320165
9	210	150		1	353822	320158
10	110	50		1	340410	311934
10	160	100		1	307073	308897
10	210	150		1	307074	308903
10	260	200		1	344295	312252
10	310	250		1	353824	320172
10	450	400	▲	1	344296	312245
10	600	550	▲	1	367014	336708
10	1000	950	▲	1	367015	336715

SDS-plus MS2 drill bits - 2 cut



Ø mm	A mm	B mm	Quantity	Id. No. 4932	EAN Code 4002395
11	160	100	1	367066	336722
11	260	210	1	399329	359578
12	160	110	1	307075	308910
12	210	160	1	307076	308927
12	260	210	1	344297	312238
12	310	260	1	353825	320189
12	450	400 ▲	1	307077	308934
12	600	550 ▲	1	367068	336746
12	1000	950 ▲	1	367017	336760
13	160	110	1	307946	309054
13	260	210	1	344298	312221
14	160	110	1	307078	308941
14	210	160	1	353826	320196
14	260	210	1	307079	308958
14	310	260	1	399330	359585
14	450	400 ▲	1	307088	309047
14	600	550 ▲	1	367018	336777
14	1000	950 ▲	1	367019	336784
15	160	110	1	373910	353392
15	260	210	1	344300	312207
16	160	110	1	307080	308965
16	210	160	1	307081	308972
16	260	210	1	399331	359592
16	310	260	1	344301	312191
16	450	400 ▲	1	307082	308989
16	600	550 ▲	1	367069	336791
16	1000	950 ▲	1	367021	336814
18	200	150	1	344303	312177
18	250	200	1	307083	308996
18	300	250	1	344304	312160
18	450	400 ▲	1	340411	311941
18	600	550 ▲	1	367022	336821
18	1000	950 ▲	1	367024	336845
20	200	150	1	344305	312153
20	250	200	1	307084	309009
20	300	250	1	399027	356126
20	450	400 ▲	1	307085	309016
20	600	550 ▲	1	367025	336876
20	1000	950 ▲	1	367026	336883
22	250	200	1	373911	353408
22	450	400 ▲	1	344307	312139
22	600	550 ▲	1	367027	336890
22	1000	950 ▲	1	367029	336913
24	250	200	1	373922	353521
24	450	400 ▲	1	307087	309030
25	250	200	1	344308	312122
25	450	400 ▲	1	344309	312115
25	1000	950 ▲	1	367030	336975
26	250	200	1	344310	323814
26	450	400 ▲	1	344311	312092

▲ Pre-drill with a short drill bit of the same diameter.

SDS-plus MS2 drill bits - 2 cut



Description	Quantity	Id. No. 4932	EAN Code 4002395
① Counter display (contains 10x 7pc SDS-plus drill set 4932352339)	1	352341	370009
② Counter display (contains 10x 10pc SDS-plus drill set 4932352340)	1	352342	370016



SDS-plus MS2 drill bits - 2 cut/10 pack

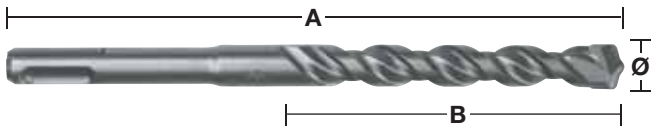

Ø mm	A mm	B mm	Quantity	Id. No. 4932	EAN Code 4002395
5	110	50	10	371702	344017
5	160	100	10	352520	371785
5.5	110	50	10	352521	371792
5.5	160	100	10	371703	344024
6	110	50	10	371704	344031
6	160	100	10	371705	344048
6	210	150	10	399337	359653
6.5	160	100	10	399338	359660
6.5	210	150	10	399339	359677
6.5	260	200	10	399340	359684
7	160	100	10	373225	348619
8	160	100	10	371706	344055
8	210	150	10	399341	359691
10	110	50	10	352522	371808
10	160	100	10	371708	344079
10	210	150	10	371709	344086
10	260	200	10	399342	359707
12	160	100	10	399343	359714
12	210	160	10	371710	344093
12	260	210	10	399344	359721
14	260	210	10	371711	344109

SDS-plus MS2 drill bits - 2 cut/50 pack



Ø mm	A mm	B mm	Quantity	Id. No. 4932	EAN Code 4002395
5	110	50	50	399176	357833
5.5	160	100	50	399177	357840
6	110	50	50	399178	357857
6	160	100	50	399179	357864
7	160	110	50	399181	357888
8	160	100	50	399182	357895
8	210	150	50	399183	357901
10	160	110	50	399345	359738
10	210	150	50	399184	357918
10	260	200	50	399185	357925
12	210	160	50	399186	357932

SDS-plus MS2 drill bits - 2 cut/cassettes



Description	Qty.	Id. No. 4932	EAN Code 4002395
① Set of 5 SDS-plus hammer drill bits. Plastic container with Ø 5/6 x 110 mm and Ø 6/8/10 x 160 mm.	1	352338	369973
① Set of 5 SDS-plus hammer drill bits. Plastic container with Ø 5.5x110 mm and Ø 5.5/6/7/8x160 mm.	1	352834	374922
① Set of 5 SDS-plus hammer drill bits. Plastic container with Ø 10/12/14/16/20 x 450 mm.	1	352801	374595
② Set of 7 SDS-plus hammer drill bits. Metal cassette with Ø 5/6/8x110 mm and Ø 6/8/10/12x160 mm.	1	352339	369980
③ Set of 10 SDS-plus hammer drill bits.	1	352340	369997
③ Metal cassette with Ø 5/6/6x110 mm and Ø 6/6/8/8/10/10/12/14x160 mm.	1	352340	369997
5pc Drill/Chisel set with SDS-plus drill bits Ø 6/8/10x160 mm, pointed and flat chisel.	1	430002	376636



SDS-plus contractor drill bits - 2 cut/10 pack

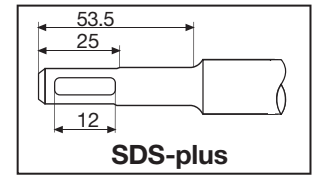
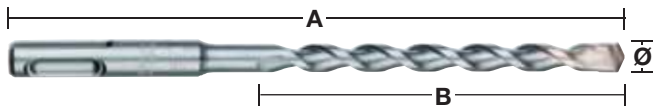

Ø mm	A mm	B mm	Quantity	Id. No. 4932	EAN Code 4002395
5.5	160	100	10	352695	373536
6	160	100	10	352696	373543
7	160	100	10	352697	373550
8	160	100	10	352698	373567
8	210	150	10	352699	373574
10	210	150	10	352700	373581

SDS-plus TCT multipurpose drill bits

These drill bits will drill in metal, wood and stone but in rotary mode only. Hammer action cannot be used with these drill bits. Ideal for tradesmen who need to drill through a variety of materials in one go.

Made in Germany.

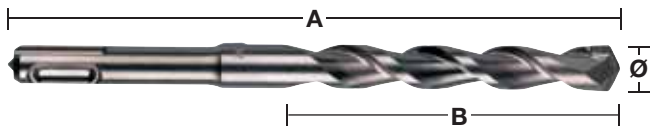

Ø mm	A mm	B mm	Quantity	Id. No. 4932	EAN Code 4002395
6	160	100	1	373918	353484
8	210	150	1	373919	353491
10	260	200	1	373920	353507
12	260	200	1	373921	353514

Grease

This grease has been especially formulated to lubricate and protect both the tool and accessories ensuring increased lifetime. Apply sparingly directly onto the reception of the drill bit, chisel or core cutter etc. Contents 50 grams.

Description	Quantity	Id. No. 4932	EAN Code 4002395
① Grease	1	352273	369324
② Counter display (contains 15x single grease tube 4932352273)	1	352274	369331

①



②



SDS-plus core cutters

Core cutters for rotary hammers up to 4 kg. All TCT cores have a M16 x 2 thread and fit to both SDS-plus and Hex 11 arbors. Arbor and pilot drill bit required additionally.



Made in Germany.

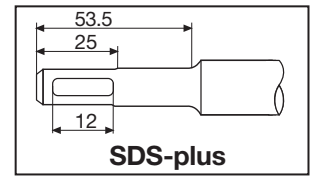

Ø mm	A mm	Quantity	Id. No. 4932	EAN Code 4002395
35	58	1	344478	312559
50	58	1	344479	312566
65	50	1	344480	312573
68	50	1	399099	357031
82	50	1	344481	312580
90	50	1	344482	312597

TCT core cutter set versions

Set version includes: TCT core cutter, SDS-plus arbor 105 mm length, TCT pilot drill bit Ø 8 x 120 mm and allen key.

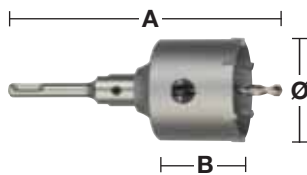

Ø mm	A mm	B mm	Quantity	Id. No. 4932	EAN Code 4002395
65	182	50	1	399295	359097
68	182	50	1	399296	359103
82	182	50	1	399297	359110

TCT core cutter arbors

Both SDS-plus and Hex arbors include an allen key and require a pilot drill bit additionally.

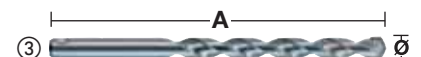
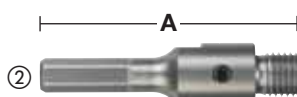
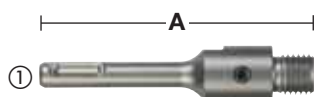

Description	Reception	Ø mm	A mm	Quantity	Id. No. 4932	EAN Code 4002395
① SDS-plus arbor	SDS-plus		105	1	399966	366255
① SDS-plus arbor	SDS-plus		370	1	399967	366262
② Hex arbor	Hex 11		90	1	399968	366279
③ TCT pilot drill bit for use in masonry / concrete etc.		8.0	120	1	399125	357291
③ TCT pilot drill bit with conical shaft for old style arbors.		10.0	100	1	399020	356058
NOT SUITABLE for above arbors.						

TCT Universal Holesaws

TCT Universal Holesaws are ideal for electricians, carpenters, kitchen fitters and all related heating, ventilation and plumbing trades.

TCT Universal Holesaws are designed for use in a wide variety of materials such as:

- Bricks* – suitable for both solid bricks and bricks with cavities
- Aerated concrete blocks*, lightweight aggregate blocks and breeze blocks
- Soft density lime-sandstone building blocks upto hardness of 30 N/mm²
- Softwoods, chipboard, plywood, medium density fibreboard (MDF)
- Plastics and plastic coated board (Contiboard)
- Gypsum/plaster board

Application areas:

- Installation of electrical switch boxes and junction boxes.
- Fitting of spot and down lights.
- Through holes for cables, water and central heating pipes.
- Openings for ventilation and extractor pipework.

** Not suitable for use in hard materials such as concrete, granite, medium to hard density lime-sandstone block, natural stone and hard bricks over 30 N/mm² hardness.*

TCT Universal Holesaws can be used with pneumatic rotary hammers with SDS-plus reception and all rotary/percussion corded and cordless drills.

Important: the percussion/hammer action mode must be turned off when using these holesaws.



Features

- ① Robust and durable**
Tungsten carbide teeth are dovetailed into the core body guaranteeing tougher material bonding and less tooth breakage.
- ② FIXTEC arbors**
There are two types of arbor reception available, (1) standard Hex shaft for use with rotary/percussion drills or cordless tools and (2) SDS-plus reception for use with pneumatic rotary hammers.
Both arbors come with an innovative self locking FIXTEC mechanism for securing the pilot drill bit, eliminating the need for awkward grub screws. Spanner flats allow the core to be easily detached from the FIXTEC arbor.
- ③ Protection**
TCT Universal Holesaws are only to be used without hammer action but in the event the hammer action is not deactivated when using the FIXTEC SDS-plus arbor, the holesaw will not be damaged.
- ④ Material removal**
Large dust chambers ensure effective and rapid material removal.
- ⑤ Core body**
Lightweight thin wall design meets less resistance for faster cleaner drilling with less vibrations.
- ⑥ Pilot drill bit**
This is available either in HSS for use in wood/plastics or carbide tipped for applications in masonry.

TCT Universal Holesaws

All TCT Universal Holesaws have a M16 thread and fit to both FIXTEC SDS-plus and Hex 11 reception arbors. FIXTEC arbor and pilot drill required additionally. Made in Germany.

Ø mm	A mm	No. of teeth	Quantity	Id. No. 4932	EAN Code 4002395
25	60	3	1	399100	357048
30	60	3	1	399101	357055
35	60	3	1	399102	357062
40	60	3	1	399103	357079
45	60	3	1	399104	357086
50	60	3	1	399105	357093
55	60	3	1	399106	357109
60	60	5	1	399108	357123
63	60	5	1	399109	357130
65	60	5	1	399110	357147
68	60	5	1	399111	357154
70	60	5	1	399112	357161
74	60	5	1	399114	357185
76	60	5	1	399115	357192
80	60	5	1	399117	357215
85	60	5	1	399118	357222
90	60	5	1	399119	357239
105	60	6	1	399120	357246

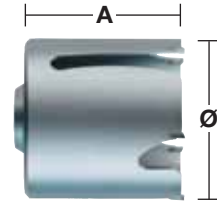
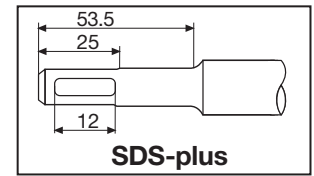

TCT Universal holesaw set version

Set version includes: TCT universal holesaw, countersink, SDS-plus arbor 118 mm length and TCT pilot drill bit Ø 8 x 120 mm. The countersink can be removed for use in wood and brick.

Ø mm	A mm	B mm	Quantity	Id. No. 4932	EAN Code 4002395
68	205	60	1	399298	359127

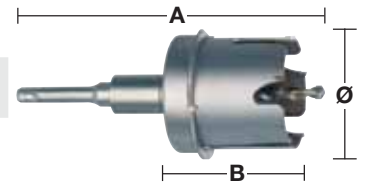

Countersink

Countersink – When fitted to the 68 mm holesaw it allows for the flush fitting of electrical switch boxes in drywall/plasterboard walls.

Ø mm	A mm	No. of teeth	Quantity	Id. No. 4932	EAN Code 4002395
68	2	3	1	399127	357314



TCT Universal holesaw system attachments

Both SDS-plus and Hex arbors require a pilot drill bit additionally.

Description	Reception	Ø mm	A mm	Quantity	Id. No. 4932	EAN Code 4002395
① FIXTEC arbor	SDS-plus		118	1	399121	357253
① FIXTEC arbor	SDS-plus		220	1	399134	357406
① FIXTEC arbor	SDS-plus		370	1	399122	357260
② FIXTEC arbor	Hex 11 mm		118	1	399123	357277
② FIXTEC arbor	Hex 11 mm		370	1	399124	357284
TCT pilot drill bit						
③ for use in masonry, brick etc.		8	120	1	399125	357291
HSS pilot drill bit						
④ for use in wood and plastic.		7.4	120	1	399126	357307

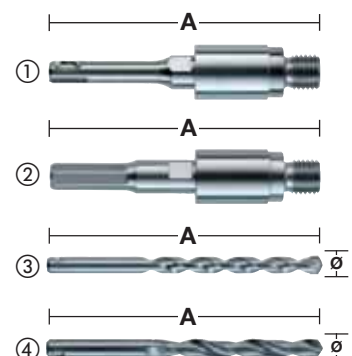

SDS-Max/21 mm K-Hex 4 cut drill bits

Large carbide tip with patented rebar chamfers.

Ensures lower vibration and optimised drilling performance when hitting reinforced steel. Longer lifetime.



Innovative, unique carbide tip. With more carbide on all diameters and extra carbide on $\varnothing > 32$ mm.

Especially developed robust head geometry with optimum 4x90° symmetry of carbide tip.

Reduces jamming up on hitting reinforcing steel.



Wear mark on both sides of primary cutter.

Guarantees diameter accuracy i.e. for anchor fittings. Life time indicator in warranty cases.

Centering point with 130° point angle.

Easy spot drilling with pinpoint accuracy and ensures optimum guidance during drilling.



Patented reinforced flute geometry.

Lower vibrations for smoother drilling. Stronger flute means less breakages. Better transfer of hammer energy to the tip.

Big, robust secondary cutter with dynamic, curved cutting edge.

Supports the primary cutter for faster drilling.

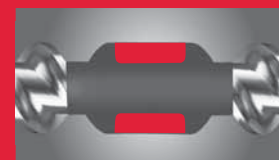

Deep flute shoulders.

High volume dust removal for optimum drilling speed less wear and heat build up.

Shorter spiral windings.



For faster transport of drilling dust from the head to the flute = Less wear and heat build up at the tip.



Low vibration drilling performance.

Comfortable drilling ensures less stress for man and machine.



Special surface treatment.

Shot blasting provides a smooth surface.

Densifies the surface structure and makes the bit more wear resistant.



PGM conformity.

Guarantees precise holes for anchor fitting over the entire lifetime of the drill bit.

SDS-Max drill bits - 4 cut

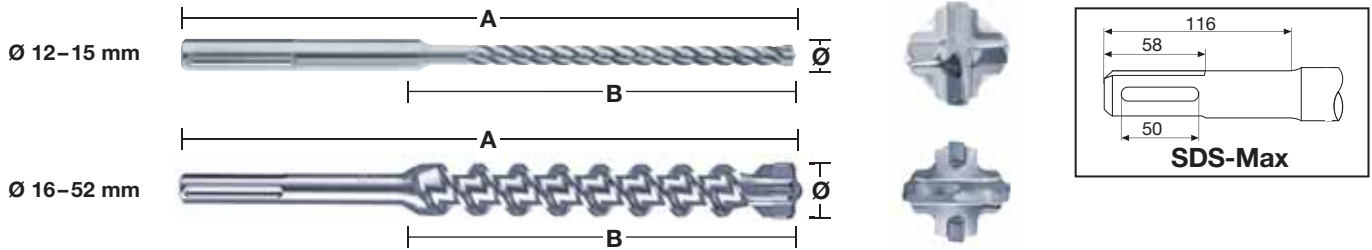

Ø mm	A mm	B mm	Quantity	Id. No. 4932	EAN Code 4002395
12	340	200	1	352750	374083
12	540	400 ▲	1	352751	374090
12	690	550	1	430727	383887
14	340	200	1	352752	374106
14	540	400 ▲	1	352753	374113
15	340	200	1	352754	374120
15	540	400 ▲	1	352755	374137
16	340	200	1	352756	374144
16	540	400 ▲	1	352757	374151
16	940	800 ▲	1	352758	374168
16	1320	1180 ▲	1	352759	374175
18	340	200	1	352760	374182
18	540	400 ▲	1	352761	374199
18	940	800 ▲	1	352762	374205
18	1320	1180 ▲	1	352763	374212
20	320	200	1	352764	374229
20	520	400 ▲	1	352765	374236
20	920	800 ▲	1	352766	374243
20	1320	1200 ▲	1	352767	374250
22	320	200	1	352768	374267
22	520	400 ▲	1	352769	374274
22	920	800 ▲	1	352770	374281
22	1320	1200 ▲	1	352771	374298
24	320	200	1	352772	374304
24	520	400 ▲	1	352773	374311
25	320	200	1	352774	374328
25	520	400 ▲	1	352775	374335
25	920	800 ▲	1	352776	374342
25	1320	1200 ▲	1	352777	374359
26	520	400	1	430728	383894
28	370	250	1	352778	374366
28	570	450 ▲	1	352779	374373
28	670	550 ▲	1	352780	374380
28	920	800 ▲	1	352781	374397
28	1320	1200 ▲	1	352782	374403
30	370	250	1	352783	374410
30	570	450	1	352784	374427
30	920	800	1	430729	383900
32	370	250	1	352785	374434
32	570	450	1	352786	374441
32	920	800 ▲	1	352787	374458
32	1320	1200 ▲	1	352788	374465
35	370	250	1	352789	374472
35	570	450	1	352790	374489
35	920	800 ▲	1	352791	374496
38	370	250	1	352792	374502
38	570	450	1	352793	374519
40	370	250	1	352794	374526
40	570	450 ▲	1	352795	374533
40	920	800 ▲	1	352796	374540
40	1320	1200 ▲	1	352797	374557
45	570	450	1	352798	374564
45	920	800	1	430730	383917
50	570	450	1	430731	383924
52	570	450	1	352799	374571
SDS-Max 5pc drill bit set Ø 16/18x540 mm and Ø 20/22/25x520 mm.			1	352800	374588

▲ Pre-drill with a short drill bit of the same diameter.

SDS-Max TCT tunnel bits - One piece design

- One piece solid steel tool.
- Increased lifetime.

- Up to 30% faster than conventional 2 piece design tools.
- Suitable for all rotary hammers.

Made in Germany.

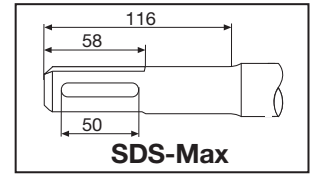
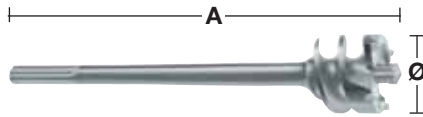

Ø mm	A mm	Quantity	Id. No. 4932	EAN Code 4002395
45	310	1	399365	359820
45	550	1	373892	353217
45	990	1	399366	359837
55	310	1	399367	359844
55	550	1	373893	353224
55	990	1	399368	359851
65	310	1	399369	359868
65	550	1	373894	353231
65	990	1	399370	359875
80	310	1	399371	359882
80	550	1	373895	353248
80	990	1	399372	359899

SDS-Max TCT core cutters - One piece design

- One piece solid steel tool.
- Increased lifetime.
- Suitable for all rotary hammers.

- Up to 30% faster than conventional 2 piece design tools.
- Supplied with pilot drill bit and ejector tool.

Made in Germany.

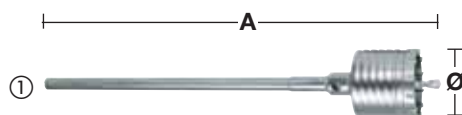

Description	Ø mm	A mm	Quantity	Id. No. 4932	EAN Code 4002395
①	50	290	1	399373	359905
	50	550	1	373884	353132
	68	290	1	399374	359912
	68	550	1	373885	353149
	80	290	1	399375	359929
	80	550	1	373886	353156
	100	550	1	373888	353170
	125	550	1	373889	353187
	150	550	1	373890	353194
② Ejector tool			1	399021	356065
③ Pilot drill bit	11	120	1	245967	307111

SDS-Max TCT core cutters - Two piece design

Not suitable for rotary hammers > 10 kg.

Made in Germany.

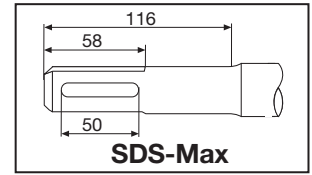
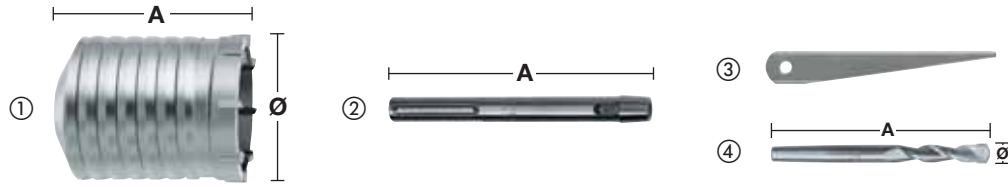

Description	Ø mm	A mm	Quantity	Id. No. 4932	EAN Code 4002395
①	40	100	1	245992	307180
	50	100	1	430732	383931
	60	100	1	430733	383948
	65	100	1	245994	307203
	68	100	1	430734	383955
	80	100	1	245995	307210
	90	100	1	430735	383962
	100	100	1	367304	336432
	125	100	1	367306	336456
	150	100	1	367308	336470
② Arbor – SDS-Max		180	1	343667	315932
		450	1	343670	315949
③ Ejector tool			1	604214	311231
④ Pilot drill bit	11	120	1	245967	307111

Adaptor



Description	Reception	Quantity	Id. No. 4932	EAN Code 4002395
Adaptor	SDS-Max → SDS-plus	1	359490	325795

21 mm K-Hexagon drill bits - 4 cut

Easy centering:

The special shaped tip design ensures accurate positioning and avoids skating on hard and smooth materials.

Optimal dust removal:

The large entrance channels remove the dust quickly from the hole for less wear rate on the tip resulting higher performance and longer lifetime.

Precise round holes:

Due to two extra carbide tips the drill bit will produce precise round holes and has also a excellent performance when hitting rebar.

High energy transfer:

The patented KVS-flute design gives the best energy transfer from the tool reception to the drill bit tip and also lowest vibration.

Made in Germany.

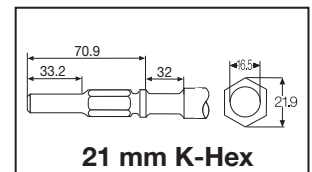
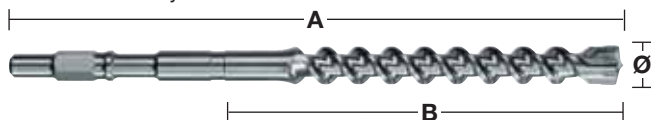

Ø mm	A mm	B mm	Quantity	Id. No. 4932	EAN Code 4002395
16	570	400 ▲	1	399560	362141
18	570	400 ▲	1	399562	362165
20	570	400 ▲	1	399564	362189
22	570	400 ▲	1	399566	362202
25	570	400 ▲	1	399569	362216
28	570	400 ▲	1	399571	362257
30	570	400 ▲	1	399572	362264
32	570	400 ▲	1	399573	362271
32	1320	1200 ▲	1	399040*	356447
35	570	400 ▲	1	399574	362288

SDS-Max vario extension system

- **Flexible tool system:** can be extended to variable lengths in combination with core cutters or tunnel bits. We recommend a maximum of 3 extensions.
- **Cost effective:** different drill sizes can be exchanged easily and fast with the threaded stud system.
- Suitable for rotary hammers up to 8 kg.

Description	Ø mm	A mm	Quantity	Id. No. 4932	EAN Code 4002395
① SDS-Max arbor		195	1	430736	383979
② Vario extension (incl. threaded stud)	25	280	1	430737	383986
③ Vario threaded stud			1	430738	383993
④ Vario threaded stud with tapered end 1:8 for TCT core cutters.			1	430748	384099
⑤ TCT core cutter	40	100	1	245992	307180
	50	100	1	430732	383931
	60	100	1	430733	383948
	65	100	1	245994	307203
	68	100	1	430734	383955
	80	100	1	245995	307210
	90	100	1	430735	383962
	100	100	1	367304	336432
	125	100	1	367306	336456
	150	100	1	367308	336470
⑥ Ejector tool			1	604214	311231
⑦ Pilot drill bit	11	120	1	245967	307111
⑧ Vario tunnel bits (supplied with thread)	30	150	1	430739	384006
	35	150	1	430740	384013
	40	150	1	430743	384044
	45	150	1	430744	384051
	55	150	1	430745	384068
	60	150	1	430741	384020
	68	150	1	430746	384075
	80	150	1	430747	384082
	90	150	1	430742	384037

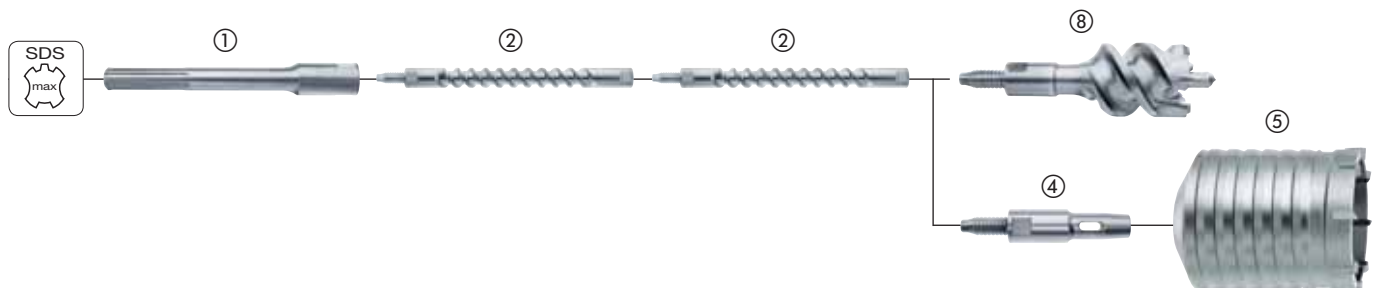
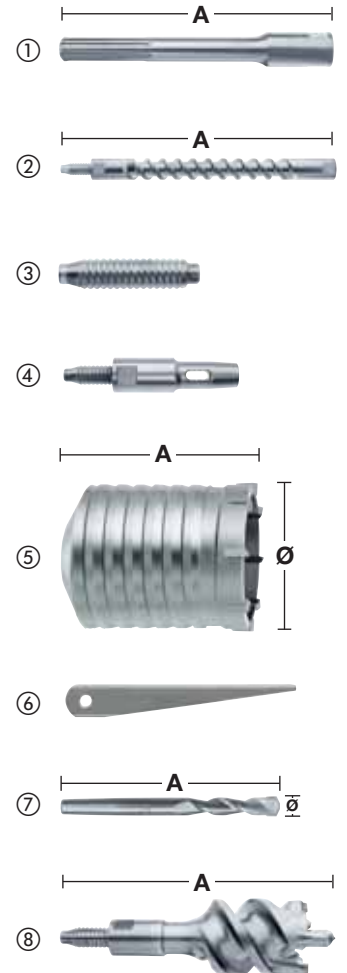



Nothing but **HEAVY DUTY.**[™]

Drill Connect

The innovative and patented Drill Connect System is the ultimate solution for those requiring maximum versatility with large diameter drilling tools.

Versatile:

Drill Connect acts as a link between machine and drilling tools. On one side the system is totally compatible to all SDS-Max reception drilling tools such as drill bits, tunnel bits and core cutters. On the opposite side between the rotary hammer and the Drill Connect attachment one can fit the extension piece with the desired length.

Universal:

The extension pieces are offered in a range of lengths fitting to rotary hammers with either SDS-Max, Spline or 19 mm Hex reception. Short or long – the choice is yours!

Cost effective:

Professional users always require both long and short length drill bits and depending on the application sometimes even of the same diameter. But now, one can reduce the total number of drilling tools with the help of the Drill Connect System which makes it possible to interchange the drilling tools diameter and length in one simple step. Therefore users can reap the benefits of purchasing the cheaper short length drill bits and extending the length with the economical extensions plus the flexibility of Drill Connect reduces the overall quantity of drill bits one must carry in their toolbox.



100% Power:

The Drill Connect attachment provides a quick and safe connection between drilling tool and extension piece and therefore ensures that 100% of the power is completely transmitted to the drill bit tip.



Less weight:

The combination of short drilling tools and 18 mm diameter extensions reduces the overall weight by up to 15%.

- We recommend that Drill Connect be cleaned of concrete dust and lubricated with grease at regular intervals (Grease – Part-no. 4932352273).
- Drill Connect is only suitable for drilling tools in excess of 32 mm diameter and limited for use with rotary hammers up to 8 kg in weight.

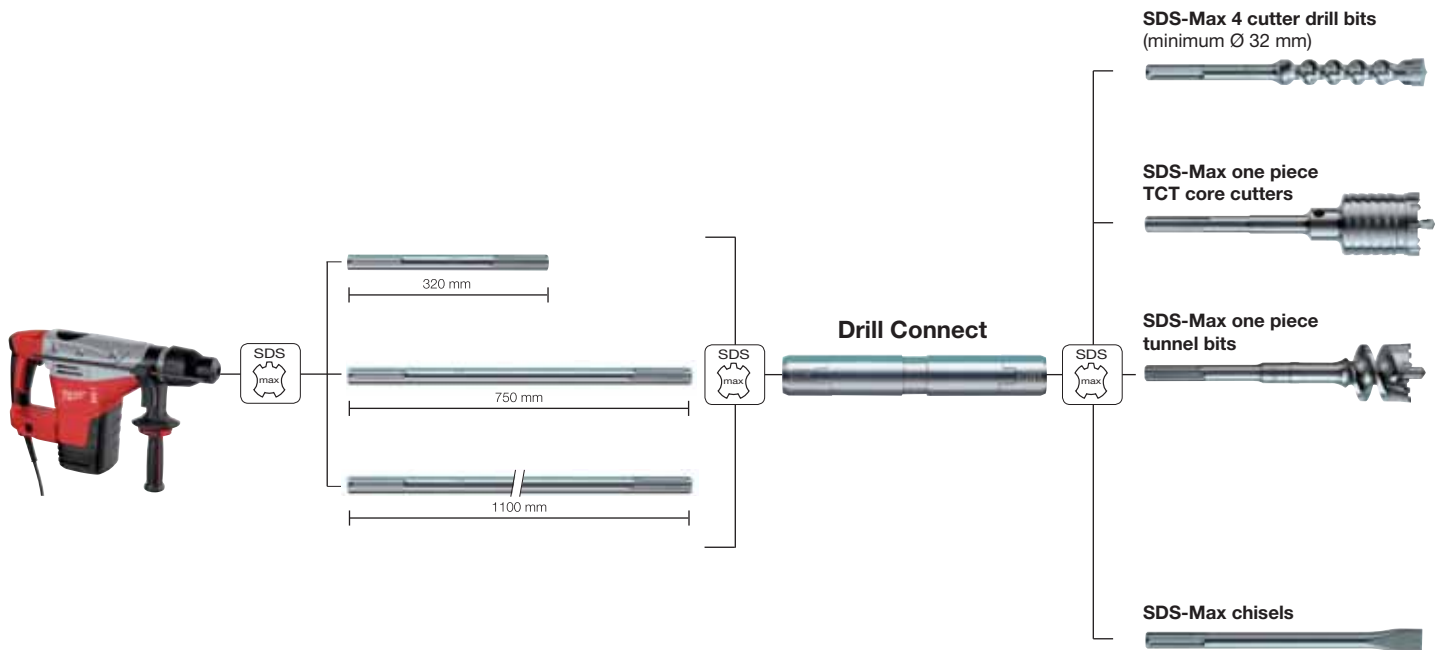

Drill Connect

Suitable for use with drilling tools with a Ø of 32 mm and above.
For use with rotary hammers up to 8 kg in weight.

Description	Machine reception A	Drilling reception B	Length mm C	Id. No. 4932	EAN Code 4002395
Drill Connect	SDS-Max	SDS-Max	190	399128	357321

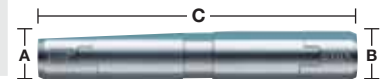

Extension pieces

Description	Machine reception A	Drill Connect reception B	Length mm C	Id. No. 4932	EAN Code 4002395
SDS-Max extension	SDS-Max	SDS-Max	320	399242	358533
SDS-Max extension	SDS-Max	SDS-Max	750	399129	357338
SDS-Max extension	SDS-Max	SDS-Max	1100	399243	358540

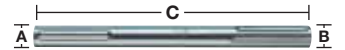

Grease

This grease has been especially formulated to lubricate and protect both the tool and accessories ensuring increased lifetime. Apply sparingly directly onto the reception of the drill bit, chisel or core cutter etc. Contents 50 grams.

Description	Quantity	Id. No. 4932	EAN Code 4002395
Grease	1	352273	369324





Nothing but **HEAVY DUTY**.™

Chisels

Every chisel comes with 150 years experience in manufacturing expertise, we know what it takes to make the best chisel. A high quality chisel needs to withstand the daily routine of breaking and demolition on the worksite, this demands a chisel with a low wear rate, impact strength and elasticity to have a low risk of breaking.

With these objectives in mind great attention is placed on sourcing the correct raw materials and to use the most up to date manufacturing techniques.

For the base material a specifically defined alloy steel is chosen, then each chisel is crafted individually through the production process of forging, sharpening, hardening, tempering and finishing.

The chisels are precision formed using traditional forging skills coupled with sophisticated machinery for the specific tip design.

The heat treatment process is totally enclosed and computer controlled ensuring consistent results, this guarantees that the complete chisel is hardened throughout to 55 HRC. The tempering operation creates a uniform hardened surface across the complete chisel to give it impact strength, more wear resistance and the required elasticity.

The chisels then go through the final finishing process which gives the chisel a smooth grain flow surface and a special corrosion resistant treatment.

Finally for identification purposes the Milwaukee® logo is laser marked on the chisel.

To achieve long service life all our chisels can be resharpened time and time again.

These chisels stand for 100% quality – Made in Germany.

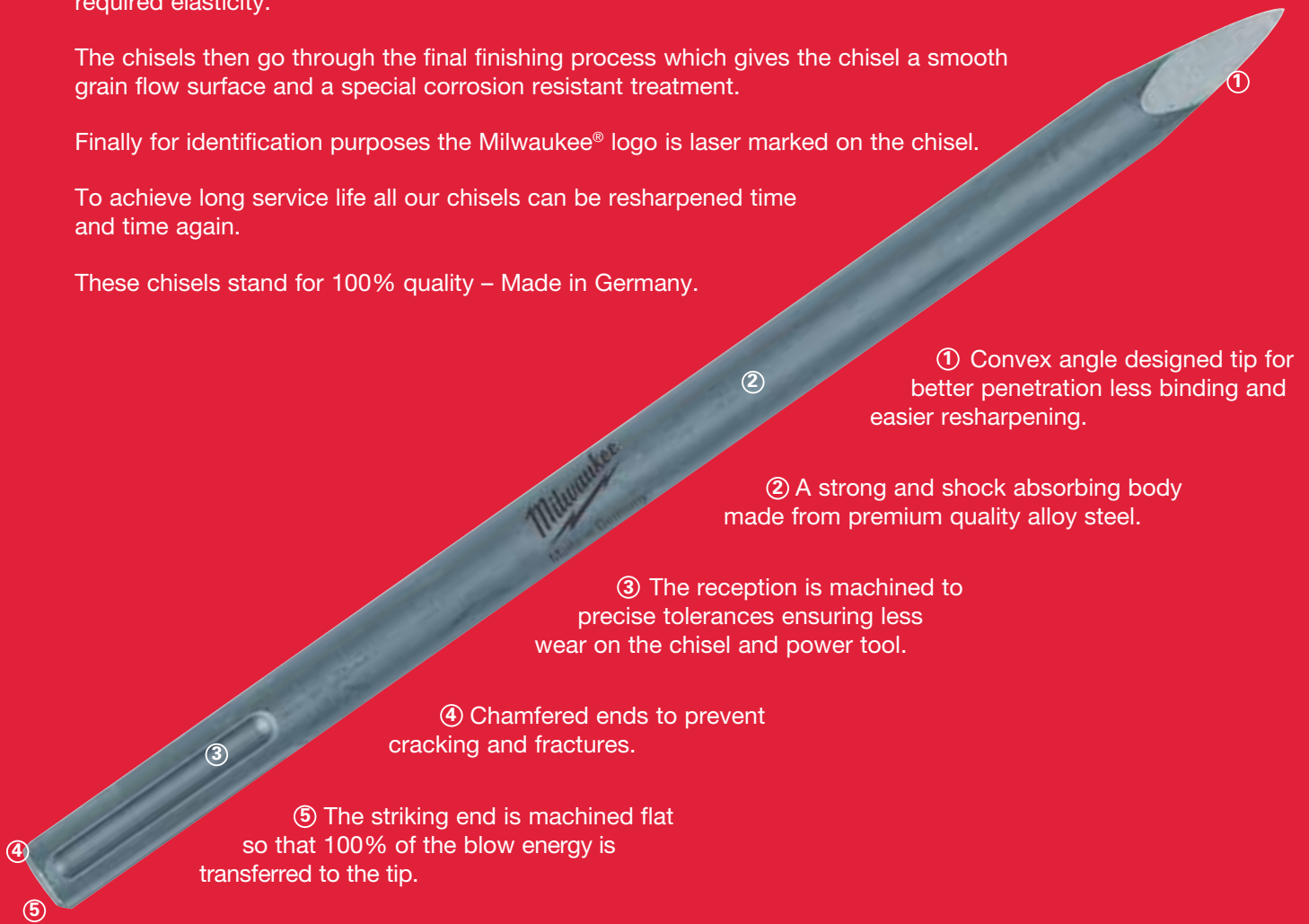

Maintenance Tips

1. Grease the reception regularly (Milwaukee® grease part no. 4932352273).
2. Keep receptions clean from dust.
3. Do not exert excessive side pressure on the chisel. Do not use as a crowbar.
4. Do not store chisels outdoors at temperatures below freezing, if so chisels should be warmed before use. Rusty chisels are more likely to suffer fatigue failure.

SDS-plus chisels

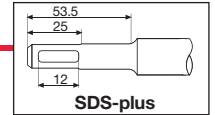

Pointed chisels

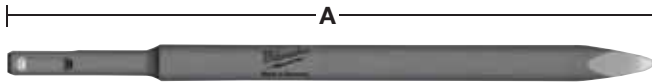

A mm	B mm	Quantity	Id. No. 4932	EAN Code 4002395
250	-	1	339625	304813

Flat chisels

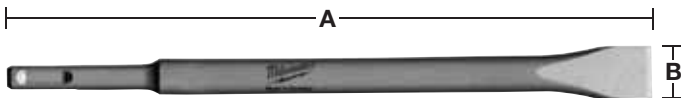

A mm	B mm	Quantity	Id. No. 4932	EAN Code 4002395
250	20	1	339626	304820

Wide chisels

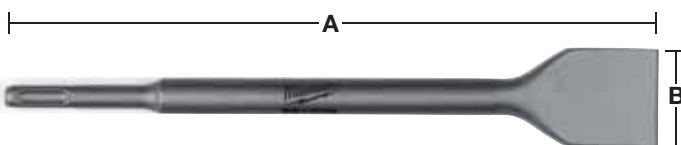

A mm	B mm	Quantity	Id. No. 4932	EAN Code 4002395
250	40	1	367146	334377

Chisel sets



Description	Quantity	Id. No. 4932	EAN Code 4002395
3pc chisel set (250 mm length) 1 x Pointed chisel 1 x Flat chisel 1 x Wide chisel	1	430001	376629

SDS-plus chisels

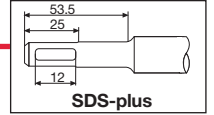

Tile removal chisels

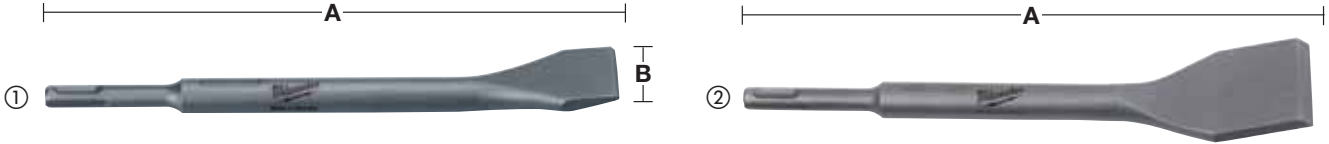

Angled head to prevent damage to walls when removing tiles.

	A mm	B mm	Quantity	Id. No. 4932	EAN Code 4002395
①	250	40	1	353424	320202
②	250	50	1	352343	370023

Gouge chisels

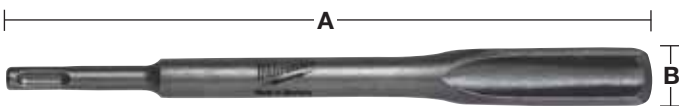

	A mm	B mm	Quantity	Id. No. 4932	EAN Code 4002395
	250	25	1	339627	304837

Plaster removal chisels

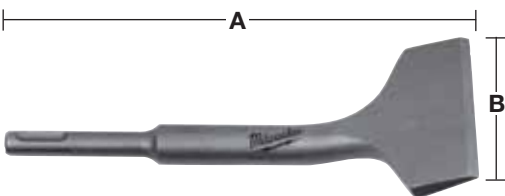

	A mm	B mm	Quantity	Id. No. 4932	EAN Code 4002395
	165	75	1	352344	370030

Floor/wall scrapers

For scraping adhesives, paint, scree and soft plaster.

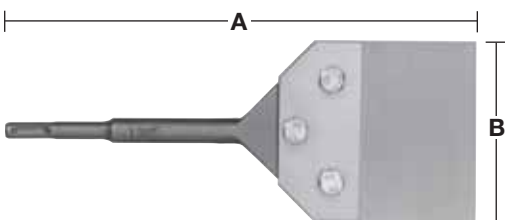

Description	A mm	B mm	Quantity	Id. No. 4932	EAN Code 4002395
Floor cleaning tool complete	250	100	1	352919	375776
Spare 1 mm thick blade with 3x bolts/nuts			1	352920	375783

SDS-Max chisels

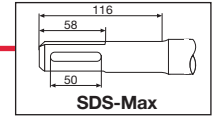

Pointed chisels

Ideal for a wide range of breaking and demolition work of concrete or breeze block.

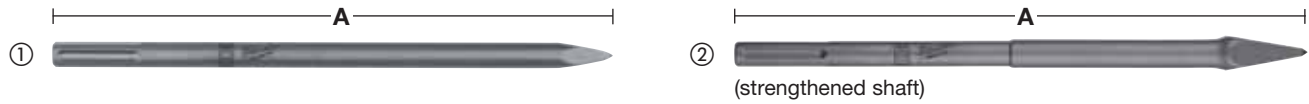

	A mm	B mm	Quantity	Id. No. 4932	EAN Code 4002395
①	280	-	1	343734	317509
②	380 (strengthened shaft)	-	1	399907	365623
①	400	-	1	343735	317516
①	400	-	20	399302	359165
①	600	-	1	343736	317523

Flat chisels

Ideal for a wide range of breaking and cutting of concrete as well as demolition work.

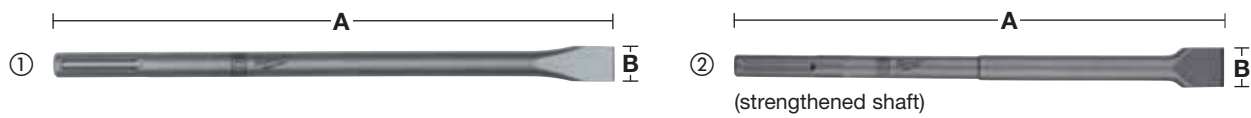

	A mm	B mm	Quantity	Id. No. 4932	EAN Code 4002395
①	280	25	1	343737	317530
②	380 (strengthened shaft)	30	1	399908	365630
①	400	25	1	343738	317547
①	400	25	20	399303	359172
①	600	25	1	343739	317554

Wide chisels

Stripping walls of plaster, ceramic tiles. Removing heavy deposits of rust and scale metal.

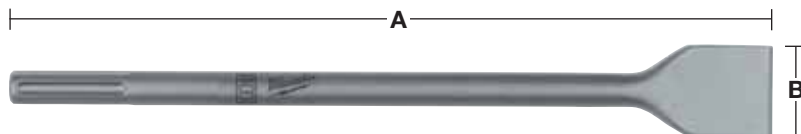

	A mm	B mm	Quantity	Id. No. 4932	EAN Code 4002395
	400	50	1	343743	317592
	300	80	1	343744	317608
	300	115	1	343745	317615

Tile removal chisels

Cranked for stripping walls of plaster and ceramic tiles.

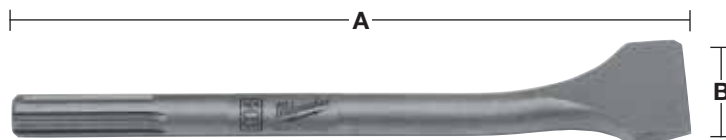

	A mm	B mm	Quantity	Id. No. 4932	EAN Code 4002395
	300	80	1	399234	358489

SDS-Max chisels

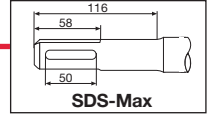

Chasing gouge chisels

Cutting grooves into a wall surface to hold pipe work or electrical conduit. Suitable for brick, breeze block and concrete.

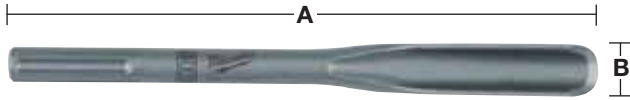

A mm	B mm	Quantity	Id. No. 4932	EAN Code 4002395
300	26	1	343740	317561

Spade chisels

Pointed end: for digging harder ground such as chalk, shingle or shale.

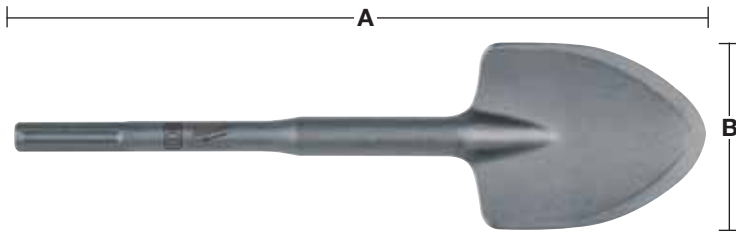

A mm	B mm	Quantity	Id. No. 4932	EAN Code 4002395
400	110	1	343747	317639

Surface treatment/bushing tools

For roughing up concrete before its surface coated ie. for pitted or uneven floors or walls must often be roughened up prior to covering with a new layer of coating. 16 teeth.

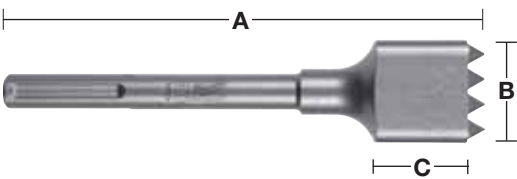

A mm	B mm	C mm	Quantity	Id. No. 4932	EAN Code 4002395
240	50	50	1	352918	375769

21 mm K-Hexagon chisels

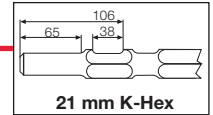

Pointed chisels

Ideal for a wide range of breaking and demolition work of concrete or breeze block.

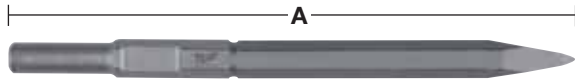

A mm	B mm	Quantity	Id. No. 4932	EAN Code 4002395
380	-	1	399251	358632
450	-	1	399252	358649
600	-	1	399253	358656

Flat chisels

Ideal for a wide range of breaking and cutting of concrete as well as demolition work.

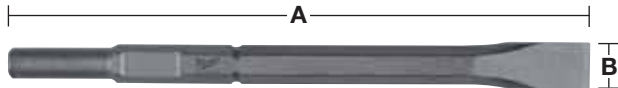

A mm	B mm	Quantity	Id. No. 4932	EAN Code 4002395
380	25	1	399256	358687
450	25	1	399257	358694
600	25	1	399258	358700

Wide chisels

Suitable for stripping walls of plaster or ceramic tiles. Removing heavy deposits of rust and scale from metal.

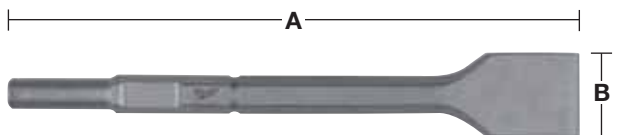

A mm	B mm	Quantity	Id. No. 4932	EAN Code 4002395
300	50	1	399260	358724
300	75	1	399261	358731

21 mm K-Hexagon chisels

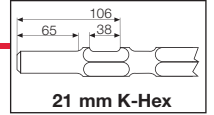

Spade chisels

Suitable for digging in all types of ground – clay, earth, chalk, shingle and shale. Also for digging in frozen ground. Not suitable for concrete.

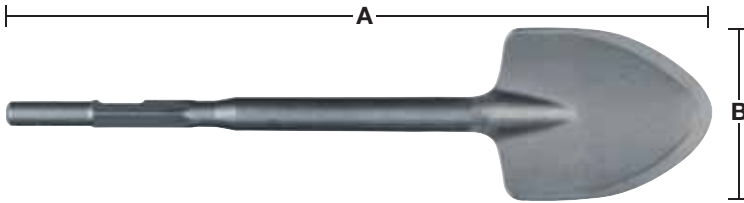

A mm	B mm	Quantity	Id. No. 4932	EAN Code 4002395
533	110	1	399264	358762

Electrode/ground rod drivers

Suitable for driving hammering electrode/ground rods. Not suitable for driving rebar or steel rods.

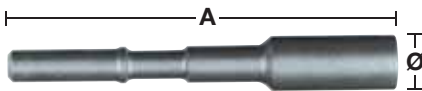

Ø mm	A mm	Quantity	Id. No. 4932	EAN Code 4002395
12	222	1	399265	358779
16	222	1	399266	358786
25	222	1	399269	358816

Dust guard

Prevents dust and dirt entering the tool reception area when using spades and ground rod drivers.



Description	Quantity	Id. No. 9170	EAN Code 4002395
Dust guard	1	086960	565504

21 mm K-Hex/SDS-Max special application tools

Tamping tools

Application:

Suitable for compacting earth and ballast prior to pouring concrete. Tamping back-fill on ditches. Requires universal taper shank.

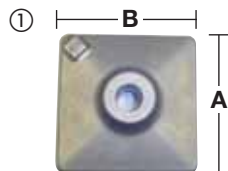

Surface treatment tools

Application:

For roughing up concrete before its surface coated ie. for pitted or uneven floors or walls must often be roughened prior to covering with a new layer of coating. Requires universal taper shank.

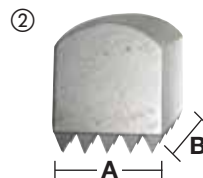

Description	A mm	B mm	Quantity	Id. No. 4932	EAN Code 4002395
① Tamping plate	120	120	1	399270	358823
② Bushing head (16 teeth)	50	50	1	399279	358915

Floor cleaning tools

Application:

For scraping floor tile adhesive, paint, scree and other floor coatings. Requires universal taper shank.

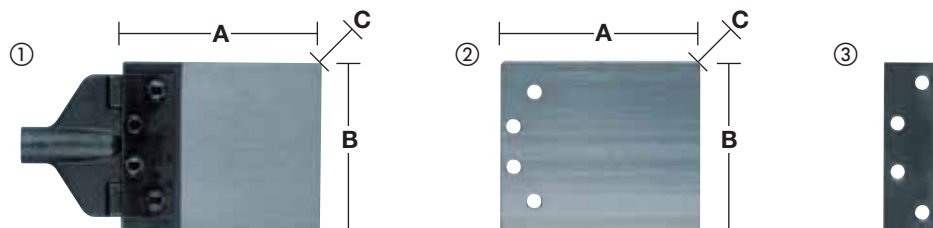

Description	A mm	B mm	C mm	Quantity	Id. No. 4932	EAN Code 4002395
Floor cleaning tool including						
① 2 mm blade. Requires universal taper shank.	180	150	2.0	1	399272	358847
② Spare 2 mm blade	180	150	2.0	1	399273	358854
Spares for floor cleaning tools						
③ Replacement clamping bracket				1	399275	358878
Service set						
Includes:				1	352300	369591
2x gaskets, 4x nuts, 4x screws, 8x washers						

Universal taper shanks



Description	A mm	Quantity	Id. No. 4932	EAN Code 4002395
① Universal taper shank SDS-Max	300	1	343771	317745
② Universal taper shank 21 mm K-Hexagon	300	1	399280	358922
	450	1	399281	358939

Name		Top view	Suitable for
① SDS-plus	drill		AEG, Milwaukee®, Bosch, Dewalt, Hilti, Hitachi, Kango, Makita, Ryobi
① SDS-plus	chisel		AEG, Milwaukee®, Bosch, Dewalt, Hilti, Hitachi, Kango, Makita, Ryobi
② SDS-Max	drill		AEG, Milwaukee®, Bosch, Dewalt, Hilti, Hitachi, Kango, Makita, Ryobi
② SDS-Max	chisel		AEG, Milwaukee®, Bosch, Dewalt, Hilti, Hitachi, Kango, Makita, Ryobi
③ Spline	drill		AEG, Milwaukee®, Bosch, Dewalt, Hilti, Hitachi, Kango, Makita, Metabo
④ Twisted spline	chisel		AEG, Milwaukee®, Bosch, Dewalt, Hilti, Hitachi, Kango, Makita, Metabo
⑤ 13 mm Hexagon	drill		Hitachi, Makita
⑥ 17 mm Hexagon	chisel		Hitachi, Makita
⑦ 19 mm K-Hexagon	chisel		Kango
⑧ 19 mm Hexagon	chisel		AEG, Milwaukee®, Bosch, Dewalt, Ryobi
⑨ 21 mm K-Hexagon	drill		Hitachi, Kango, Makita, Milwaukee®
⑩ 21 mm K-Hexagon	chisel		Hitachi, Kango, Makita, Milwaukee®
⑪ 28 mm Hexagon	chisel		AEG, Milwaukee®
⑫ 32 mm Hexagon	chisel		Atlas Copco, Kango, Milwaukee®

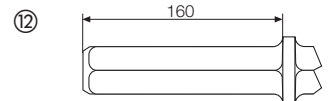
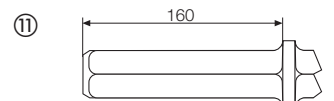
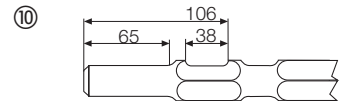
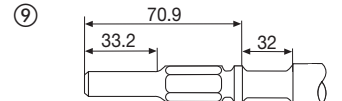
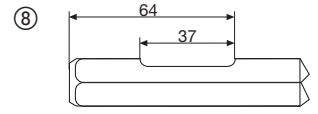
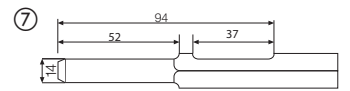
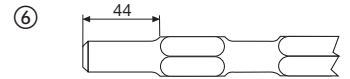
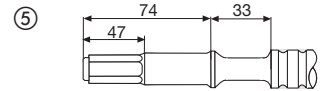
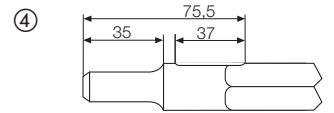
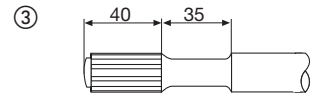
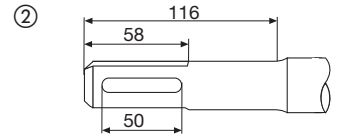
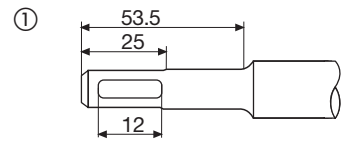

Concrete drill bits - round shank - DIN 8039

Diamond ground percussion carbide tip with two cutting edges. For drilling in brick, tile, ceramic, concrete, plaster, slate and aerated concrete blocks.

Made in Germany.

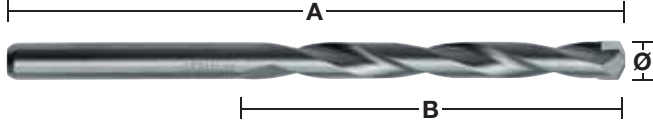

Ø mm	A mm	B mm	Quantity	Id. No. 4932	EAN Code 4002395	
3	70	40	1	363630	332007	
3.5	80	45	1	399916	365746	
4	85	50	1	363631	332014	
4.5	85	50	1	363632	332021	
5	85	50	1	363633	332038	
5	150	90	1	363634	332045	
5.5	85	50	1	363635	332052	
5.5	150	90	1	367035	333998	
6	100	60	1	363636	332069	
6	150	90	1	363637	332076	
6	200	150	1	399383	360000	
6	400	350	1	352505	371631	
6	600	550	1	352506	371648	
6.5	100	60	1	363638	332083	
6.5	150	90	1	367036	334605	
7	100	60	1	363639	332090	
7	150	90	1	367037	334612	
7.5	100	60	1	399917	365753	
8	120	80	1	363640	332106	
8	200	150	1	363641	332113	
8	400	350	1	399384	360017	
8	600	550	1	352507	371655	
8.5	120	80	1	363642	332120	
9	120	80	1	363643	332137	
9.5	120	80	1	399919	365777	
10	120	80	1	363644	332144	
10	200	150	1	363645	332151	
10	400	350	1	399385	360024	
10	600	550	1	352508	371662	
10	1000	950	1	352509	371679	
11	150	85	1	363646	332168	
12	150	85	1	363647	332175	
12	200	150	1	363648	332182	
12	400	350	1	399386	360031	
12	600	550	1	352510	371686	
12	1000	950	1	352511	371693	
13	150	90	1	363649	332199	
13	400	350	1	352512	371709	
14	150	90	1	363650	332205	
14	400	350	1	399387	360048	
14	600	550	1	352513	371716	
15	160	100	1	399380	359974	
16	160	100	1	373914	353446	
16	400	350	1	399388	360055	
16	600	550	1	352514	371723	
18	160	100	1	399229	358434	
18	400	350	1	352515	371730	
20	160	100	1	399230	358441	
20	400	350	1	399389	360062	
20	600	550	1	352516	371747	
22	400	350	1	352517	371754	
①	Concrete drill bit set (5-piece). Plastic cassette with Ø 4/5/6/8/10 mm.			1	352333	369928
②	Concrete drill bit set (8-piece). Plastic cassette with Ø 3/4/5/6/7/8/9/10 mm.			1	352334	369935

①



②



Concrete Super drill bits - round shank - DIN 8039

These high quality concrete drill bits have a unique shaped drill head with centering point and a H-spiral flute for maximum drilling speed and longer lifetime in hard materials such as concrete, aerated concrete blocks, masonry, natural stone, artificial stone, ceramic tile, slate and granite. From Ø 12 mm the drill bits are supplied with a multi-flat shank to prevent the drill bit slipping in the chuck.

Made in Germany.

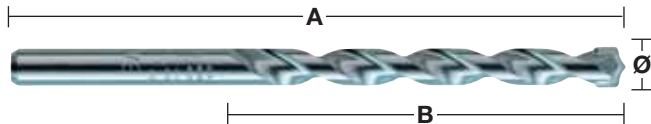

Ø mm	A mm	B mm	Quantity	Id. No. 4932	EAN Code 4002395
3	70	40	1	399394	360116
4	85	50	1	399395	360123
5	85	50	1	399396	360130
5.5	85	50	1	399397	360147
6	100	60	1	399398	360154
6.5	100	60	1	399399	360161
7	100	60	1	399400	360178
8	120	80	1	399401	360185
9	120	80	1	399402	360192
10	120	80	1	399403	360208
12	150	90 ▲	1	399404	360215
14	150	90 ▲	1	399405	360222
15	160	100 ▲	1	399406	360239
16	160	100 ▲	1	399407	360246
18	160	100 ▲	1	399408	360253
20	160	100 ▲	1	399409	360260
Concrete Super drill bit set (5-piece).					
①	Plastic cassette with Ø 4/5/6/8/10 mm.			1	352336 369959
Concrete Super drill bit set (7-piece).					
②	Plastic cassette with Ø 4/5/5.5/6/7/8/10 mm.			1	352337 369966

▲ with multi-flat shank



Multi material drill bits

These tungsten carbide tipped (TCT) drill bits will drill in metal, wood and stone but in rotary mode only. Hammer action cannot be used with these drill bits. Ideal for tradesmen who need to drill through a variety of materials in one go.

Made in Germany.

①

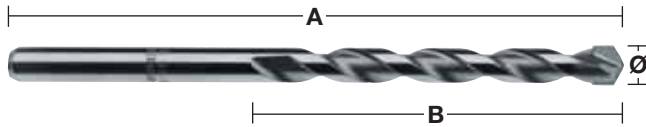

Ø mm	A mm	B mm	Quantity	Id. No. 4932	EAN Code 4002395
3	70	40	1	430147	378081
4	85	50	1	430148	378098
5	85	50	1	430149	378104
5.5	85	50	1	430150	378111
5.5	150	90	1	430151	378128
6	100	60	1	430152	378135
6	150	90	1	430153	378142
6	200	150	1	430154	378159
6.5	150	90	1	430155	378166
6.5	200	150	1	430156	378173
7	100	60	1	430157	378180
8	120	80	1	430158	378197
8	250	200	1	430159	378203
10	120	80	1	430160	378210
10	250	200	1	430161	378227
12	150	90	1	430162	378234
① Multi material drill bit set (7-piece). Plastic cassette with Ø 3/4/5/6/6/8/10 mm.			1	352335	369942
Multi material drill bit set (7-piece). Plastic cassette with Ø 4/5/5.5/6/7/8/10 mm.			1	352836	374946

Glass & tile bits

Suitable for glass, tiles, mirrors, ceramics.

Made in Germany.

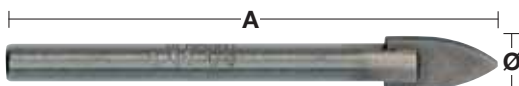

Ø mm	A mm	Quantity	Id. No. 4932	EAN Code 4002395
3	90	1	399393	360109
4	90	1	363884	333585
5	90	1	363885	333592
6	90	1	363886	333608
8	95	1	363887	333615
10	100	1	363888	333622

Impact rated wood auger bits

Suitable for use with all types of corded / cordless drills including impact wrenches.

Drilling with an impact wrench enables drilling holes with less effort, one hand drilling, drilling up a ladder and above head height with less risk of injury from the tool clutching out.

Special zone hardening process ensures an extra hard shank, durable tip and perfectly flexible bit body.

New Milwaukee[®] Through-Center head geometry with the lead cutting edge lines up with the center of the feed screw.

This ensures efficient chip removal and allows for continuous feeding.

20° rake angle of the lead cutting edge creates a path for easy chip ejection.

Polished and powder coated flute design produces a non-stick surface for increased chip ejection, reduced chip clogging and higher selffeeding capability.

Milling marks are removed in the finishing process, creating a smooth surface.

Lewis flute with large, wide throat design for rapid chip removal.

Sharp ground cutting lips for smooth clean holes.

Resharpenable cutting lips.

With 7/16" shank. To fit square drive 1/2" impact wrenches the adaptor 48660061 is required.

Suitable for hard & soft wood, wet & treated wood, plywood, chipboard, WPC (wood plastic composite), laminated beams and panels, exotic and hard woods e.g. bongossi, iroko, teak, beech, oak, etc.



Short series

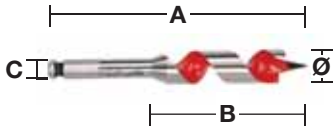

Special short design enables drilling in tight and normally non accessible places.

Ø mm	A mm	B mm	C inch	Quantity	Id. No.	UPC Code 45242
18	153	100	7/16" Hex	1	48130683	091379
20	153	100	7/16" Hex	1	48130813	091522
22	153	100	7/16" Hex	1	48130873	091638
25	153	100	7/16" Hex	1	48131003	091782
28	153	100	7/16" Hex	1	48131123	091935
32	153	100	7/16" Hex	1	48131253	092031

Long series

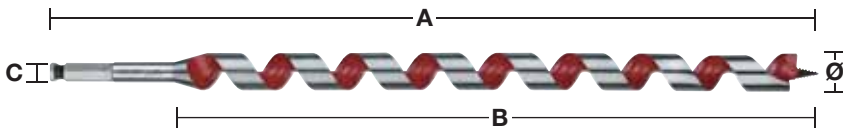

Ø mm	A mm	B mm	C inch	Quantity	Id. No. 4932	EAN Code 4002395
14	470	395	7/16" Hex	1	352275	369348
16	470	395	7/16" Hex	1	352276	369355
18	470	395	7/16" Hex	1	352277	369362
20	470	395	7/16" Hex	1	352278	369379
22	470	395	7/16" Hex	1	352279	369386
24	470	395	7/16" Hex	1	352280	369393
26	470	395	7/16" Hex	1	352281	369409
28	470	395	7/16" Hex	1	352282	369416
30	470	395	7/16" Hex	1	352283	369423
32	470	395	7/16" Hex	1	352284	369430

① 5-piece set in pouch

with Ø 14/16/18/20/22x470 mm.

1

352285

369447

System accessories

Description	Quantity	Id. No.	UPC Code 45242
Adaptor: 1/2" square drive to 7/16" and Hex 11 mm. For use with 7/16" selffeed bits and impact auger bits.	1	48660061	155118



Wood drilling speeds

The following tables give recommended drilling speeds for the most efficient cutting speed. The tables should only be used as a guide and are dependant on the user and material being drilled.

Auger bits

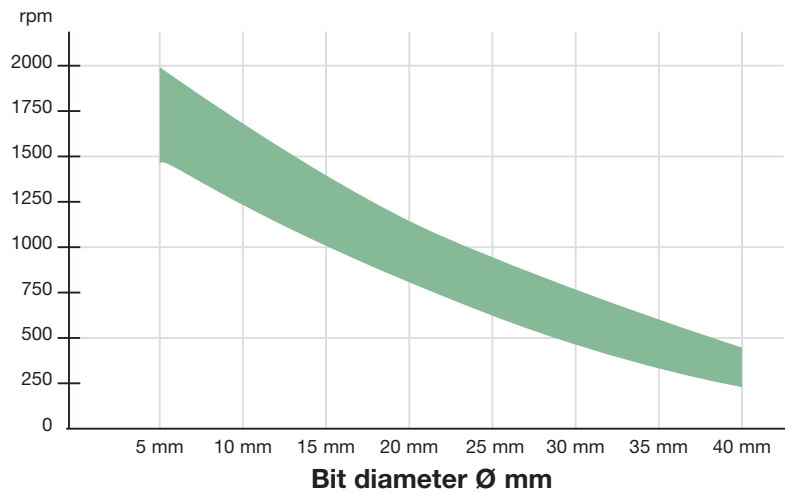

Optimum drilling speed range in rpm

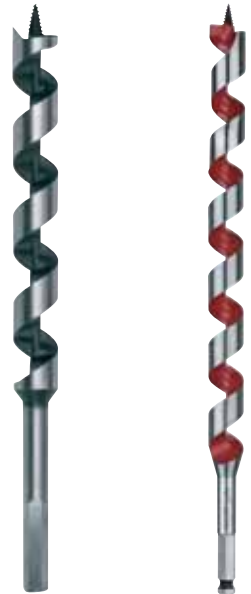

Forstner bits / Selffeed bits

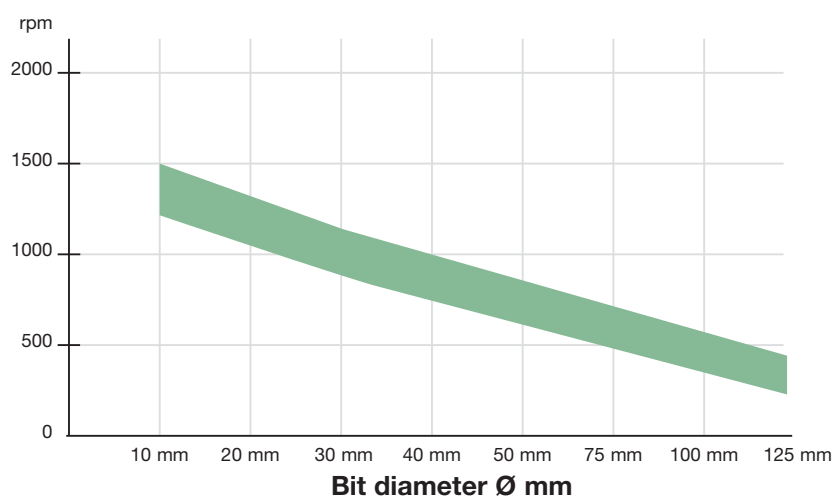

Optimum drilling speed range in rpm



Wood auger bits

For heavy duty, precision drilling in soft and hard wood, large section beams, joists, floor boarding, chipboard and plywood. Lewis flute design for rapid chip removal. With Hex shank for secure chuck grip.

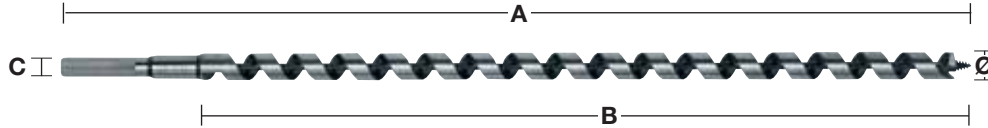

Ø mm	A mm	B mm	C mm	Quantity	Id. No. 4932	EAN Code 4002395
6	230	155	6.5	1	430175	378364
6	460	385	6.5	1	430176	378371
8	230	155	6.5	1	363681	331796
8	460	385	6.5	1	363688	331710
10	230	155	8.5	1	363682	331802
10	460	385	8.5	1	363689	331727
10	600	530	8.5	1	363696	331642
12	230	155	10	1	363683	331819
12	460	385	10	1	363690	331734
12	600	530	10	1	363697	331659
14	230	155	11	1	363684	331826
14	460	385	11	1	363691	331741
14	600	530	11	1	363698	331666
16	230	155	11	1	363685	331833
16	460	385	11	1	363692	331758
16	600	530	11	1	363699	331673
18	230	155	11	1	363686	331840
18	460	385	11	1	363693	331765
18	600	530	11	1	363700	331680
20	230	155	11	1	363687	331857
20	460	385	11	1	363694	331772
20	600	530	11	1	363701	331697
22	230	155	11	1	373363	347889
22	460	385	11	1	363695	331789
22	600	530	11	1	363702	331703
24	230	155	11	1	373364	347896
24	460	385	11	1	373370	348558
26	230	155	11	1	373365	348503
26	460	385	11	1	373371	348565
28	230	155	11	1	373366	348510
28	460	385	11	1	373372	348572
30	230	155	11	1	373367	348527
30	460	385	11	1	373373	348589
32	230	155	11	1	373368	348534
32	460	385	11	1	373374	348596
①	Wood auger bits (6-piece). Wood case with Ø 8/10/12/14/16/18 mm x 230 mm.			1	373380	349258
②	Wood auger bits (6-piece). Wood case with Ø 10/12/14/16/18/20 mm x 460 mm.			1	373381*	364589



Forstner bits

Centre point for precisely locating the bit, peripheral cutters ensure splinter free drilling in all natural soft and hard woods. Manufactured according to DIN 74836. Suitable for heavy-duty applications in all naturals, soft and hard woods.

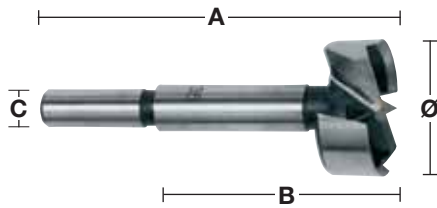

Ø mm	A mm	B mm	C mm	Quantity	Id. No. 4932	EAN Code 4002395
10	90	50	8	1	363703	331468
12	90	50	8	1	363704	331475
14	90	50	8	1	363705	331482
15	90	50	8	1	363883	333738
16	90	50	8	1	363706	331499
18	90	50	8	1	363707	331505
20	90	50	8	1	363708	331512
25	90	50	8	1	363711	331543
26	90	50	8	1	363712	331550
30	90	50	8	1	363714	331574
32	90	50	10	1	363715	331581
35	90	50	10	1	363717	331604
40	90	50	10	1	363720	331635
50	90	50	10	1	373923	353538
① Forstner bits (5-piece). Wood case with Ø 15/20/25/30/35 mm.				1	373379	349241

TCT Hinge boring forstner bits

Special designed carbide tipped bits for extra long life and high performance. Manufactured according to DIN 74836. Suitable for drilling harder materials such as hard wood, chipboard, fibre wood board and laminated wood.

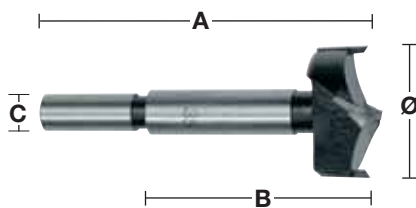

Ø mm	A mm	B mm	C mm	Quantity	Id. No. 4932	EAN Code 4002395
25	90	50	8	1	373689*	352197
30	90	50	8	1	373690*	352203
35	90	50	10	1	373691*	352302
40	90	50	10	1	373692*	352401

* while stocks last

SWITCHBLADE[™] Selffeed bits

- **Speed:** aggressive feed screw design allows the bit to pull through the wood faster and without effort, resulting in faster drilling.
- **Replaceable SWITCHBLADE[™]:** the SWITCHBLADE[™] replaceable blade system ensures your blade is always razor sharp. It increases productivity by eliminating resharping downtime and it increases the overall life of the bit.
- **Application:** suitable for all general contractors, electricians, plumbers and HVAC engineers who require to drill through holes in wood for all types of pipe, vents and wire trunking.



Each Selffeed bit is supplied with 2x blades, 2x replaceable feed screws, 2x set screws and 1x allen key.

Ø mm	A mm	Quantity	Id. No.	UPC Code 45242
35	7/16" Hex	1	48255120	157471
38	7/16" Hex	1	48255125	157488
51	7/16" Hex	1	48255135	157495
54	7/16" Hex	1	48255140	157525
57	7/16" Hex	1	48255143	225903
65	7/16" Hex	1	48255150	157532



SWITCHBLADE[™] 5 piece kit

Description	Id. No.	UPC Code 45242
SWITCHBLADE[™] 5 piece kit incl. 4 SWITCHBLADE [™] Selffeed bits Ø 35/38/54/65 mm QUIK-LOK extension 140 mm length 4x Replacement SWITCHBLADE [™] blades (1 for each size bit) 4x Feed screws 4x Set screws 1x Allen key	49225100	157686



SWITCHBLADE[™] replacement blades

Ø mm	Quantity	Id. No.	UPC Code 45242
35	1	48255420	225842
38	1	48255425	225859
51	1	48255435	225866
54	1	48255440	225873
57	1	48255443	225880
65	1	48255450	226474

Service kit in storage container Contains: 1x feed screw, 2x set screws, 1x allen key, 1x storage container also can store spare SWITCHBLADES [™]	1	48255280	225934
--	---	----------	--------



Selffeed bits

All sizes have removable and replaceable feed screws. Two feed screws supplied with each bit. Feed screw provides fast, effortless feeding even in gummy woods. Internal cutting plane shaves hole radius for clean, smooth holes without pressure.

Each selffeed bit is supplied with 2x feed screws, 1x set screw and 1x allen key.

Ø mm	A mm	Quantity	Id. No.	UPC Code 45242
25	7/16" Hex	1	48251002	119028
29	7/16" Hex	1	48251122	119073
32	7/16" Hex	1	48251252	119127
35	7/16" Hex	1	48251372	119172
38	7/16" Hex	1	48251502	119226
44	7/16" Hex	1	48251752	119271
51	7/16" Hex	1	48252002	119325
54	7/16" Hex	1	48252122	119370
57	7/16" Hex	1	48252252	119424
65	7/16" Hex	1	48252562	119479
Feed screw – coarse thread 1/4"		1	48286870	122707
Allen key – 1/8"		1	49960060	221455
Set screw		1	06832625	-



Large selffeed bits

Large selffeed bits in 76, 92 and 116 mm sizes have double internal cutter blades that shave hole radius for clean, smooth holes without pressure. Replaceable arbor.

Ø mm	A	Quantity	Id. No.	UPC Code 45242
76	3 milled flats	1	48253001	119509
92	3 milled flats	1	48253621	119554
116	3 milled flats	1	48254621	119608
Replaceable arbor		1	48070201	088904
Feed screw – regular thread		1	48286880	122806
Set screw		1	06833150	-
Allen key 5/32"		1	49960070	221554



7-bit contractors kit

Description	Id. No.	UPC Code 45242
7-bit contractors kit incl. selffeed bits Ø 25/29/32/38/44/54/65 mm, extension 140 mm length and feed screws.	49220130	180301



Shank extensions

For selffeed bits, auger bits and holesaws (25 mm/1" diameter and larger) with 7/16" Hex shank.

	A mm	Quantity	Id. No.	UPC Code 45242
①	140 QUIK-LOK	1	48281030	122653
	300	1	48284006	122516
②	450	1	48284011	122561
	600	1	48284016	122615

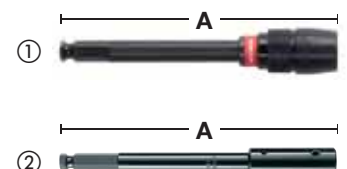

Lip & spur/brad point bits for wood - DIN 7487 E

Suitable for drilling hardboard, plywood, chipboard and all natural hard and soft wood.
Produced according to DIN 7487 E.

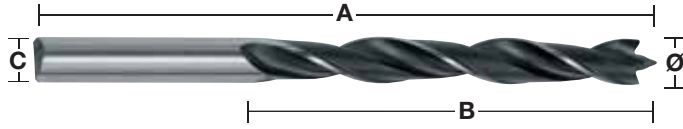

Ø mm	A mm	B mm	C mm	Quantity	Id. No. 4932	EAN Code 4002395
3	60	33	3	1	363651	331307
4	75	43	4	1	363652	331314
5	86	52	5	1	363653	331321
6	97	60	6	1	363654	331338
7	109	69	7	1	363655	331345
8	117	75	8	1	363656	331352
9	125	80	9	1	363657	331369
10	133	87	10	1	363658	331376
11	142	89	10	1	363659	331383
12	151	96	10	1	363660	331390
13	151	96	10	1	363661	331406
14	151	97	10	1	363662	331413
15	151	97	10	1	363663	331420
16	151	97	10	1	363664	331437
18	180	120	10	1	363665	331444
20	200	130	10	1	363666	331451
①	Wood drill bit set (5-piece). Plastic cassette with Ø 4/5/6/8/10 mm.			1	352465	371242
②	Wood drill bit set (8-piece). Plastic cassette with Ø 3/4/5/6/7/8/9/10 mm.			1	352466	371259

Flat boring bits

Fast drilling of big diameters. Suitable for drilling in natural hard and softwood and chipboard

- Ideal for door locks, morticing, electrical and plumbing work.
- 1/4" Hex shank reception (DIN E 6.3) for direct insertion into the power tool or for secure chuck grip.
- Ground centre point for accurate positioning and sharp wings for improved cutting performance.



Ø mm	A mm	Quantity	Id. No. 4932	EAN Code 4002395
6	152	1	352487	371457
6	400	1	352488	371464
8	152	1	363130	332618
8	400	1	352489	371471
10	152	1	363131	332625
10	400	1	352490	371488
12	152	1	363132	332632
12	400	1	352491	371495
13	152	1	363133	332649
13	400	1	352492	371501
14	152	1	363134	332656
14	400	1	352493	371518
16	152	1	363135	332663
16	400	1	352494	371525
18	152	1	363136	332670
18	400	1	352495	371532
19	152	1	363137	332687
19	400	1	352496	371549
20	152	1	363138	332694
20	400	1	352497	371556
22	152	1	363139	332700
22	400	1	352498	371563
24	152	1	363140	332717
25	152	1	363141	332724
25	400	1	352499	371570
26	152	1	363142	332731
28	152	1	363143	332748
28	400	1	352500	371587
30	152	1	363144	332755
30	400	1	352501	371594
32	152	1	363145	332762
32	400	1	352502	371520
36	152	1	363146	332779
35	400	1	352503	371617
38	152	1	363147	332786
8pc Flat bit set				
① with Ø 12/16/18/20/22/25/28/32 mm in wooden box. 152 mm length.				
		1	352504	371624

Extension

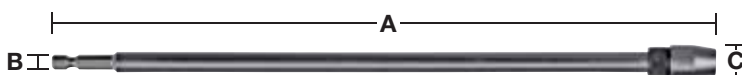

Description	A mm	B inch	C inch	Quantity	Id. No. 4932	EAN Code 4002395
Extension	305	E 6.3 1/4"Hex	1/4"Hex	1	363148	332793

Speed Feed™ wood drill bits

Step up from flat bit in quality and performance - faster drilling, higher lifetime and less jamming!

Dual cutting edges for fast and aggressive cut – up to 10 times faster drilling vs. flat boring bit.

Tapered design for reduced chip clogging, less friction and less jamming even in tough applications – results in less breakages.

Feed screw with coarse thread increases selffeeding in all types of wood – soft & hard, wet & treated.

Polished and powder coated flute design for increased chip ejection, reduced clogging and higher selffeeding capability.

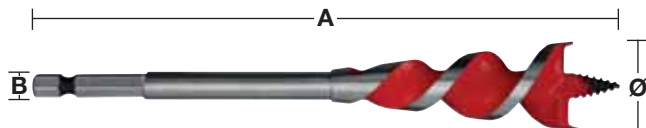

Dual cutting edges



Tapered design

Ø mm	Ø inch	A mm	B inch	Quantity	Id. No.	UPC Code 45242
13	1/2"	165	1/4" Hex	1	48130048	224807
16	5/8"	165	1/4" Hex	1	48130058	224814
20	3/4"	165	1/4" Hex	1	48130068	224821
22	7/8"	165	1/4" Hex	1	48130078	224838
25	1"	165	1/4" Hex	1	48130088	224845
32	1 1/4"	165	1/4" Hex	1	48130108	224852
4pc Set with Ø 13/16/20/25 mm.				4	48130400	234448

HSS Cable bits - DIN 7490

Manufactured from HSS steel for increased lifetime. Suitable for drilling through holes in wood, plasterboard and metal channel.

Manufactured according to DIN 7490 and conforming to the German Employer's Liability Insurance Association in terms of safety requirements for the building trade. The body of the drill bit is attached to the cylindrical shank by means of a thread, therefore eliminating the risk of breakage and guaranteeing absolute concentricity. The small twist angle and enlarged flutes ensure rapid and clog-free chip removal.

Made in Germany.

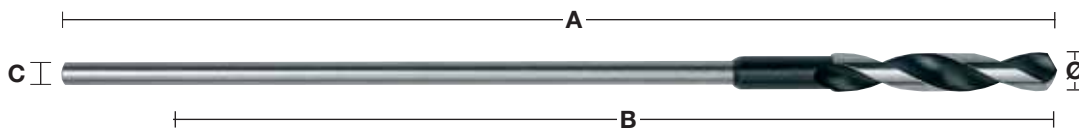

Ø mm	A mm	B mm	C mm	Quantity	Id. No. 4932	EAN Code 4002395
6	400	300	5	1	399672	363223
6	600	500	5	1	399675	363254
8	400	300	6	1	363667	331932
8	600	500	6	1	363674	331864
10	400	300	8	1	363668	331949
10	600	500	8	1	363675	331871
12	400	300	8	1	363669	331956
12	600	500	8	1	363676	331888
14	400	300	8	1	363670	331963
14	600	500	8	1	363677	331895
16	400	300	10	1	363671	331970
16	600	500	10	1	363678	331901
18	400	300	10	1	363672	331987
18	600	500	10	1	363679	331918
20	400	300	10	1	363673	331994
20	600	500	10	1	363680	331925
22	400	300	10	1	399673	363230
22	600	500	10	1	399676	363261
24	400	300	11	1	399674*	363247
24	600	500	11	1	399677*	363278

HSS Drill bit tip geometry

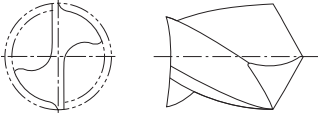
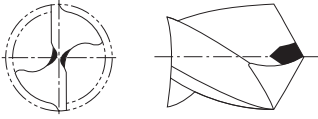
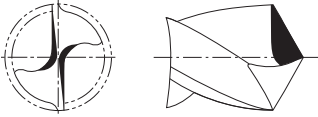
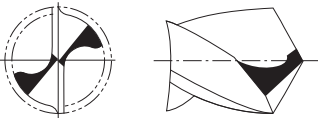
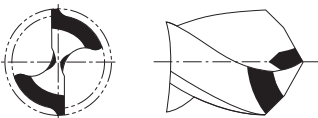
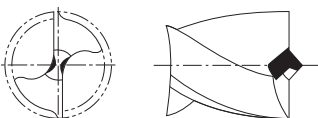
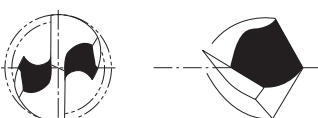
		Standard/Form	Application	Features
		Normal Standard Point	For standard drilling in ferrous/non ferrous metals and plastics	The wide cutting edge provides a drill bit that is robust and resistant to sideways pressure. Due to the wide cutting edge higher feed pressure is required. Can be easily resharpened.
		Chisel Edge Point DIN 1412 A	For drilling work in solid steel with large diameter drill bits.	Good and easy centering. Requires very low feed pressure – approx. 30% less than a normal point drill bit.
		Chisel Edge Point with corrected cutting edge DIN 1412 B	For drilling in high strength steel and high alloy steels. Also suitable for drilling thin sheet material.	Robust and resistant to sideways pressure.
		Split Point DIN 1412 C	For drilling in high strength steel and high alloy steels. Suitable for deep drilling bits.	Excellent chip removal makes this design ideal for deep drilling applications. Good centering. Low feed pressure required.
		Double Angle Point for Cast Iron DIN 1412 D	For drilling cast iron.	Extended major cutting edges reduce wear on the cutting corners for improved lifetime. Good heat conduction. Resistant to sideways pressure.
		Centre Point DIN 1412 E	For drilling thin sheet metal and soft materials.	Easy centering. Low feed pressure required. Does not snatch when drilling thin materials. Accurate and clean holes.
		U Point	For high performance drilling in high strength steels such as stainless and acid resistant steel.	Easy centering. Produces small metal chips ensuring low heat build up and quicker material resulting in faster drilling.

HSS Drill bit application guide





The following table gives recommended drilling speeds for the most efficient cutting speed. The tables should only be used as a guide and are dependant on the user and material being drilled. Coolants and lubricants will improve tool life by up to 5 times and workpiece finish.

Material class		Material type	Hardness/ Tensile Strength N/mm ²	Rockwell	Hole diameter Ø mm – RPM					Cooling agent
					Ø 1-2	Ø 3-5	Ø 6-10	Ø 11-15	Ø 16-20	
Steel	Speed	Non-alloyed construction steel, non-alloyed case hardened steel	< 400	< HRB 69	4770	1870	930	630	470	Drilling emulsion, cutting oil
			400-800	< HRC 21	4450	1770	870	580	430	
		Sheet Steel	< 800	< HRC 21	4450	1760	860	560	430	Drilling emulsion, ester oil
		Non-alloyed tool steel	< 800	< HRC 21	4440	1760	860	560	430	Drilling emulsion, cutting oil
		Alloyed tool steel	< 800	< HRC 21	3950	1550	780	520	390	Drilling emulsion, ester oil
			> 800	> HRC 21	1950	800	390	275	200	
	Alloyed hardened & tempered steel	< 1200	< HRC 37	2100	890	450	300	210	Drilling emulsion, ester oil	
> 1200		> HRC 38	1350	540	260	170	120			
Feed	Feed (mm/rev)				0.03	0.09	0.15	0.20	0.25	
Stainless steel	Speed	Stainless steel	< 1000	< HRC 30	2250	930	450	290	220	Rapeseed oil, cutting oil
		Stainless steel	1000-1200	HRC 30-37	1430	560	280	190	130	
	Feed	Feed (mm/rev)				0.02	0.06	0.13	0.18	0.24
Cast iron	Speed	Malleable cast iron	750	HRB 99	4700	2000	1100	800	600	Dry
		Soft	450	HRB 75	4500	1700	950	650	550	Drilling emulsion, cutting oil
		Hard	700	HRB 96	3450	1350	680	440	340	
	Feed	Feed (mm/rev)				0.05	0.10	0.16	0.20	0.25
Aluminium	Speed		< 350	< HRC 59	8700	3560	1720	1130	860	Drilling emulsion, cutting oil
	Feed	Feed (mm/rev)				0.02	0.08	0.13	0.18	0.23
Copper	Speed				5100	2000	990	670	500	Drilling emulsion, cutting oil
	Feed	Feed (mm/rev)				0.02	0.10	0.20	0.28	0.35
Bronze	Speed				7950	3190	1480	1010	770	Dry
	Feed	Feed (mm/rev)				0.02	0.11	0.21	0.32	0.35
Brass	Speed				7950	3190	1480	1010	770	Drilling emulsion
	Feed	Feed (mm/rev)				0.02	0.11	0.21	0.32	0.35
Magnesium	Speed				9550	3800	1900	1250	970	Dry
	Feed	Feed (mm/rev)				0.05	0.10	0.25	0.30	0.35
Plastics	Speed	PVC, Polyamide, Thermoplastics			3500	2500	1800	700	450	Water
	Feed	Feed (mm/rev)				0.05	0.10	0.16	0.21	0.23

RPM: The number of revolutions that a spindle/a cutting tool completes in one minute.

Feed: This is the linear distance at which the cutter is advanced against the workpiece during one rotation of the cutting tool. It is expressed in units of distance per revolution – millimetres per revolution.

HSS Drill bit application guide

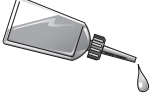
									
Material class	Material type	Hardness/ Tensile Strength N/mm ²	Rockwell	HSS-R DIN 338	HSS-G Thunderweb DIN 338 DIN 340 DIN 1897 Double Ended	HSS-G Cobalt DIN 338	HSS-G step drills 1/4 Hex reception	HSS-G cone drills 1/4 Hex reception	Cooling agent
Steel	Non-alloyed construction steel, non-alloyed case hardened steel	< 400	< HRB 69		●	●	●	●	Drilling emulsion, cutting oil
		400–800	< HRC 21	●	●	●	●	●	
	Sheet Steel	< 800	< HRC 21		●	●	●	●	Drilling emulsion, ester oil
	Non-alloyed tool steel	< 800	< HRC 21	●	●	●	●	●	Drilling emulsion, cutting oil
	Alloyed tool steel	< 800	< HRC 21		●	●	●	●	Drilling emulsion, ester oil
		> 800	> HRC 21		●	●	▲	▲	
Alloyed hardened & tempered steel	< 1200	< HRC 37				●	▲	▲	Drilling emulsion, ester oil
	> 1200	> HRC 38				●	▲	▲	
Stainless steel	Stainless steel	< 1000	< HRC 30		▲	●	▲	▲	Rapeseed oil, cutting oil
	Stainless steel	1000–1200	HRC 30–37			●	▲	▲	
Cast iron	Malleable cast iron	750	HRB 99	●	●	●	●	●	Dry
	Soft	450	HRB 75	●	●	●	●	●	Drilling emulsion, cutting oil
	Hard	700	HRB 96	●	●	●	●	●	
Aluminium		< 350	< HRC 59		▲	●	●	●	Drilling emulsion, cutting oil
Copper					▲	●	●	●	Drilling emulsion, cutting oil
Bronze				●	●	●	●	●	Dry
Brass				●	●	●	●	●	Drilling emulsion
Magnesium						●			Dry
Plastics	PVC, Polyamide, Thermoplastics				●	●	●	●	Water
Wood				●	●	●			Dry

● Most suitable. Recommended for these materials. ▲ Suitable. Recommended for intermittent use in these materials.

Metal drill bits HSS Rollforged - DIN 338 with reduced shank

High speed steel rollforged metal drill bits produced according to DIN 338. Oxide coating enables quick swarf removal. Normal point shaped cutting tip with 118° angle. Type N flute normal angle. Suitable for drilling in steel, cast iron, alloyed and non-alloyed material up to 800 N/mm². Colour: black.

Ø 13.5 mm – Ø 16 mm = 10 mm shank / Ø 16.5 mm – Ø 20 mm = 13 mm shank

Ø mm	A mm	B mm	Quantity	Id. No. 4932	EAN Code 4002395
13.5	160	108	1	373318	348435
14.0	160	108	1	373319	348442
14.5	169	114	1	373320	348459
15.0	169	114	1	373321	348466
15.5	178	120	1	373322	348473
16.0	178	120	1	373323	348480
16.5	184	125	1	373324	348497
17.0	184	125	1	373325	349104
17.5	191	130	1	373326	349111
18.0	191	130	1	373327	349128
18.5	198	135	1	373328	349135
19.0	198	135	1	373329	349142
19.5	205	140	1	373330	349159
20.0	205	140	1	373331	349166

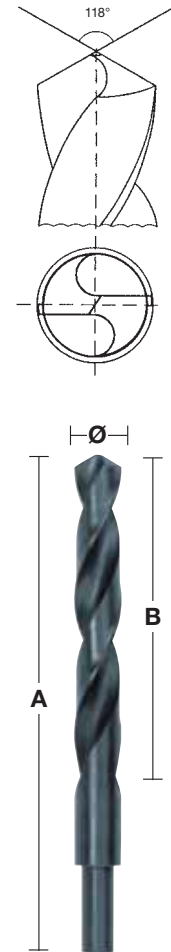

Metal drill bits HSS Rollforged - DIN 338/cassettes

Description	Id. No. 4932	EAN Code 4002395
HSS-R drill bits (19-piece). Metal cassette		
① with Ø 1/1.5/2/2.5/3/3.5/4/4.5/5/5.5/6/6.5/7/7.5/8/8.5/9/9.5/10 mm.	352468	371273
HSS-R drill bits (25-piece). Metal cassette		
② with Ø 1/1.5/2/2.5/3/3.5/4/4.5/5/5.5/6/6.5/7/7.5/8/8.5/9/9.5/10/10.5/11/11.5/12/12.5/13 mm.	352469	371280

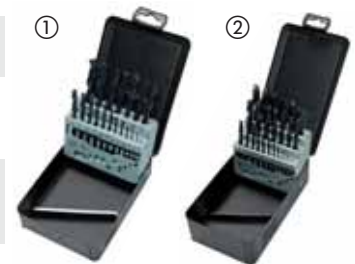

Metal drill bits HSS Rollforged - DIN 338 - 5 and 10 pack

High speed steel rollforged metal drill bits produced according to DIN 338. Oxide coating enables quick swarf removal. Normal point shaped cutting tip with 118° angle. Type N flute normal angle. Suitable for drilling in steel, cast iron, alloyed and non-alloyed material up to 800 N/mm². Colour: black.

Ø mm	A mm	B mm	Quantity	Id. No. 4932	EAN Code 4002395
1.0	34	12	10	363444	329458
1.5	40	18	10	363449	329502
2.0	49	24	10	363454	329557
2.5	57	30	10	363459	329601
3.0	61	33	10	363464	329656
3.2	65	36	10	363466	329670
3.5	70	39	10	363469	329700
4.0	75	43	10	363474	329755
4.2	75	43	10	363476	329779
4.5	80	47	10	363479	329809
4.8	86	52	10	363482	329830
5.0	86	52	10	363484	329854
5.5	93	57	10	363489	329908
6.0	93	57	10	363494	329953
6.5	101	63	10	363499	330003
6.8	109	69	10	363502	330034
7.0	109	69	10	363504	330058
7.5	109	69	10	363509	330102
8.0	117	75	10	363514	330157
8.5	117	75	10	363519	330201
9.0	125	81	10	363524	330256
9.5	125	81	10	363529	330300
10.0	133	87	10	363534	330355
10.5	133	87	5	363539	330409
11.0	142	94	5	363544	330454
11.5	142	94	5	363549	330508
12.0	151	101	5	363554	330553
12.5	151	101	5	363559	330607
13.0	151	101	5	363564	330652



Metal drill bits HSS Rollforged - DIN 338 - 345pc cabinet

Ø mm	A mm	B mm	Quantity	Id. No. 4932	EAN Code 4002395
Metal drill bit cabinet with HSS Rollforged metal drill bits (345-piece)				352674	373321
1.0	34	12	20		
1.5	40	18	20		
2.0	49	24	20		
2.5	57	30	20		
3.0	61	33	20		
3.5	70	39	20		
4.0	75	43	20		
4.5	80	47	20		
5.0	86	52	20		
5.5	93	57	20		
6.0	93	57	20		
6.5	101	63	20		
7.0	109	69	10		
7.5	109	69	10		
8.0	117	75	20		
8.5	117	75	10		
9.0	125	81	10		
9.5	125	81	5		
10.0	133	87	10		
10.5	133	87	5		
11.0	142	94	5		
11.5	142	94	5		
12.0	151	101	5		
12.5	151	101	5		
13.0	151	101	5		



THUNDERWEB

Metal drill bits HSS Ground - DIN 338



THUNDERWEB

The **THUNDERWEB** design is characterised by a conical shaped web which gets thicker towards the back of the drill bit. The web is the internal core of the drill bit.

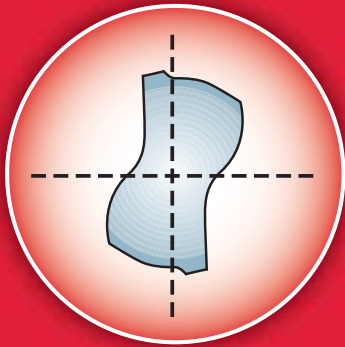

Parabolic web cross section

- Large web thickness. Strength built in.
- Accepts higher feed pressure and torque.
- Less breakages. Good for drilling deep holes and on curved surfaces.
- Long life.



Standard drill bit

The web on standard drill bits is a constant thickness throughout the length of the bit.

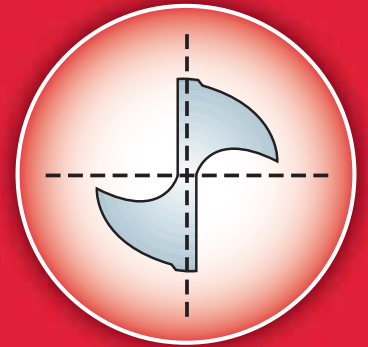

Conventional type web cross section

THUNDERWEB SPECIFICATION

FLUTE GEOMETRY

- **THUNDERWEB** flute form ejects hot chips rapidly. Disseparates heat better increasing lifetime.
- Open flute form reduces drill drawback when drilling deeper holes.
- Sharpened edges reduce binding for faster cleaner cuts.
- Flatter twist angle creates smaller chippings, ideal for drilling harder steels ie. stainless steel.

135° SPLIT POINT

- Precision starting, drill bit won't walk.
- Penetrates quickly.
- Good for drilling on curved surfaces.
- Requires less effort/feed pressure.
- Excellent for very hard materials.



THUNDERWEB - Metal drill bits HSS Ground - DIN 338

Ø mm	A mm	B mm	Quantity	Id. No. 4932	EAN Code 4002395
1.0	34	12	2	352345	370047
1.5	40	18	2	352346	370054
2.0	49	24	2	352347	370061
2.5	57	30	2	352348	370078
3.0	61	33	2	352349	370085
3.2	65	36	2	352350	370092
3.5	70	39	2	352351	370108
4.0	75	43	2	352352	370115
4.2	75	43	1	352353	370122
4.5	80	47	1	352354	370139
4.8	86	52	1	352355	370146
5.0	86	52	1	352356	370153
5.5	93	57	1	352357	370160
6.0	93	57	1	352358	370177
6.5	101	63	1	352359	370184
6.8	109	69	1	352360	370191
7.0	109	69	1	352361	370207
7.5	109	69	1	352362	370214
8.0	117	75	1	352363	370221
8.5	117	75	1	352364	370238
9.0	125	81	1	352365	370245
9.5	125	81	1	352366	370252
10.0	133	87	1	352367	370269
10.5	133	87	1	352368	370276
11.0	142	94	1	352369	370283
11.5	142	94	1	352370	370290
12.0	151	101	1	352371	370306
12.5	151	101	1	352372	370313
13.0	151	101	1	352373	370320

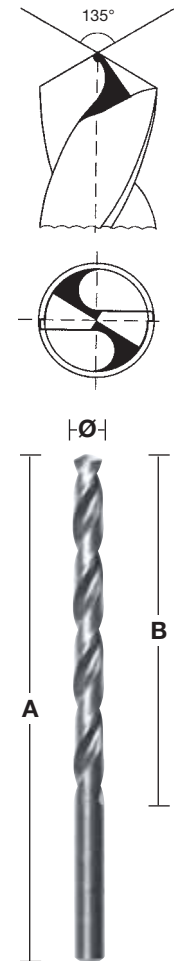

THUNDERWEB - DIN 338/5 and 10 pack

Ø mm	A mm	B mm	Quantity	Id. No. 4932	EAN Code 4002395
1.0	34	12	10	352377	370368
1.5	40	18	10	352378	370375
2.0	49	24	10	352379	370382
2.4	57	30	10	430569	382309
2.5	57	30	10	352380	370399
3.0	61	33	10	352381	370405
3.2	65	36	10	352382	370412
3.5	70	39	10	352383	370429
3.8	75	43	10	430547	382088
4.0	75	43	10	352384	370436
4.2	75	43	10	352385	370443
4.5	80	47	10	352386	370450
4.8	86	52	10	352387	370467
5.0	86	52	10	352388	370474
5.2	86	52	10	430548	382095
5.5	93	57	10	352389	370481
5.6	93	57	10	430570	382316
5.8	93	57	10	430549	382101
6.0	93	57	10	352390	370498
6.2	101	63	10	430550	382118
6.4	101	63	10	430571	382323
6.5	101	63	10	352391	370504
6.8	109	69	5	352392	370511
7.0	109	69	5	352393	370528
7.2	109	69	5	430551	382125



THUNDERWEB - DIN 338/5 and 10 pack

Ø mm	A mm	B mm	Quantity	Id. No. 4932	EAN Code 4002395
7.5	109	69	5	352394	370535
8.0	117	75	5	352395	370542
8.2	117	75	5	430552	382132
8.4	117	75	5	430553	382149
8.5	117	75	5	352396	370559
9.0	125	81	5	352397	370566
9.5	125	81	5	352398	370573
10.0	133	87	5	352399	370580
10.5	133	87	5	352400	370597
11.0	142	94	5	352401	370603
11.5	142	94	5	352402	370610
12.0	151	101	5	352403	370627
12.5	151	101	5	352404	370634
13.0	151	101	5	352405	370641



Metal drill bits THUNDERWEB - DIN 338 cassettes

①	THUNDERWEB HSS-G (19-piece), plastic cassette with Ø 1/1.5/2/2.5/3/3.5/4/4.5/5/5.5/6/6.5/7/7.5/8/8.5/9/9.5/10 mm.	1	352374	370337
②	Counter display (contains 6 x 19pc HSS-G drill set 4932352374)	1	352375	370344
③	THUNDERWEB HSS-G (25-piece), plastic cassette with Ø 1/1.5/2/2.5/3/3.5/4/4.5/5/5.5/6/6.5/7/7.5/8/8.5/9/9.5/10/10.5/11/11.5/12/12.5/13 mm.	1	352376	370351



Metal drill bits HSS Ground Long - DIN 340/5 and 10 pack

Drill bit quality: high quality high speed steel. Tip geometry: split Point DIN 1412 C. Point angle: 135°. Tolerance: h8. Flute/Helix angle: type N flute and normal 20–30° angle. Right hand cutting edge. Surface/Colour: polished silver.

Split point shaped cutting tip according to DIN 1412 C with 135° angle for improved centering. Reduces walking for accurate drilling on irregular surfaces.

Polished type N flute with right hand cutting edge, eliminates binding for faster chip removal and faster cutting with less effort.

Application: most suited for drilling deep holes in channels or where there are hollow sections. Suitable for drilling in steel, cast iron, alloyed and non-alloyed material up to 900 N/mm². Also suitable for wood and plastics.

Ø mm	A mm	B mm	Quantity	Id. No. 4932	EAN Code 4002395
2.0	85	56	10	430328	379897
2.5	95	62	10	430329	379903
3.0	100	66	10	430330	379910
3.5	112	73	10	430331	379927
4.0	119	78	10	430332	379934
4.5	126	82	10	430333	379941
5.0	132	87	10	430334	379958
5.5	139	91	10	430335	379965
6.0	139	91	10	430336	379972
6.5	148	97	10	430337	379989
7.0	156	102	10	430338	379996
8.0	165	109	10	430339	380008
9.0	175	115	10	430340	380015
10.0	184	121	10	430341	380022
11.0	195	128	5	430342	380039
12.0	205	134	5	430343	380046
13.0	205	134	5	430344	380053

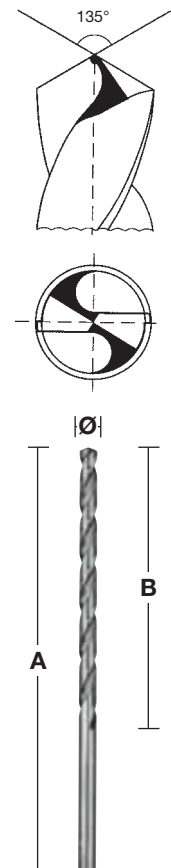

Metal drill bits HSS Ground Short - DIN 1897

Drill bit quality: high quality high speed steel.

Tip geometry: split Point DIN 1412 C.

Point angle: 118°. Tolerance: h8.

Flute/Helix angle: type N flute and normal 20–30° angle.

Right hand cutting edge. Surface/Colour: polished silver.

Withstands high drill point pressure due to short overall length.

Excellent concentricity. Polished type N flute with right hand cutting edge, eliminates binding for faster chip removal and faster cutting with less effort.

Application: most suited for drilling sheet and thin walled materials. Suitable for drilling in sheet steel, thin alloyed and non-alloyed material up to 900 N/mm². Also suitable for wood and plastics.

Ø mm	A mm	B mm	Quantity	Id. No. 4932	EAN Code 4002395
2.0	38	12	10	352200	368532
2.5	43	14	10	352201	368549
3.0	46	16	10	352202	368556
3.2	49	18	10	352203	368563
3.3	49	18	10	352204	368570
3.5	52	20	10	352205	368587
3.7	52	20	10	352206	368594
4.0	55	22	10	352207	368600
4.2	55	22	10	352208	368617
4.5	58	24	10	352209	368624
4.8	62	26	10	352210	368631
5.0	62	26	10	352211	368648
5.2	62	26	10	352212	368655
5.5	66	28	10	352213	368662
6.0	66	28	10	352214	368679
6.5	70	31	10	352215	368686
7.0	74	34	10	352216	368693
7.5	74	34	5	352217	368709
8.0	79	37	5	352218	368716
8.5	79	37	5	352219	368723
9.0	84	40	5	352220	368730
10.0	89	43	5	352221	368747

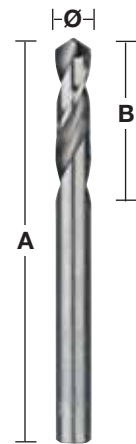
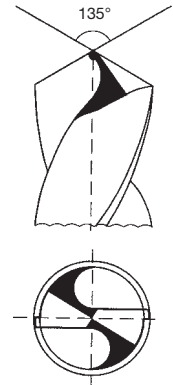

Metal drill bits HSS Ground - Double Ended

Drill bit quality: high quality high speed steel.

Tip geometry: split Point DIN 1412 C. Point angle: 135°. Tolerance: h8.

Flute/Helix angle: type N flute and normal 20–30° angle.

Right hand cutting edge. Surface/Colour: polished silver. Split point tip for good centering.

Both ends can be used. Due to its short length it can be used with higher feed pressure without the risk of breakage. Excellent concentricity. Polished type N flute with right hand cutting edge, eliminates binding for faster chip removal and faster cutting with less effort.

Application: suitable drilling in steel, non-ferrous metals and plastic.

Most suitable for thin sheet materials, e.g. rivet holes.

Ø mm	A mm	B mm	Quantity	Id. No. 4932	EAN Code 4002395
2.5	43	10	10	352222	368754
3.0	46	11	10	352223	368761
3.2	49	12	10	352224	368778
3.3	49	12	10	352225	368785
3.5	52	14	10	352226	368792
4.0	55	14	10	352227	368808
4.1	55	14	10	352228	368815
4.2	55	14	10	352229	368822
4.5	58	16	10	352230	368839
4.8	62	18	10	352231	368846
5.0	62	18	10	352232	368853
5.5	66	19	10	352233	368860
6.0	66	19	10	352234	368877

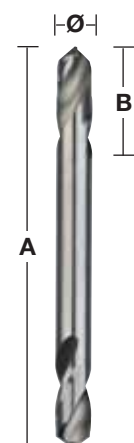
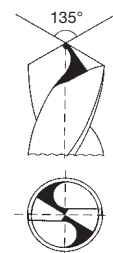

Metal drill bits HSS-G Cobalt - DIN 338

Metal drill bits ground from solid extremely heat resistant cobalt-alloyed high speed steel produced according to DIN 338. Polished finish. Split point shaped cutting tip with 135° angle for improved centering – no center punch required. 5% Cobalt content. Withstands high drilling heat. Type N flute normal angle. Suitable for drilling high alloy content steels and metals with tensile strengths over 1000 N/mm² like heat and acid proof steels and stainless steel. Colour: bronze.

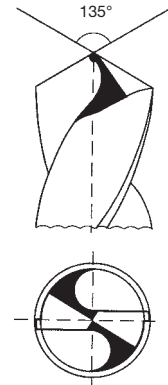

Ø mm	A mm	B mm	Quantity	Id. No. 4932	EAN Code 4002395
1.0	34	12	2	363248	333080
1.5	40	18	2	363249	333097
2.0	49	24	2	363250	333103
2.5	57	30	2	363251	333110
3.0	61	33	2	363253	333134
3.2	65	36	2	363254	333141
3.5	70	39	2	363256	333165
4.0	75	43	2	363258	333189
4.2	75	43	1	363260	333202
4.5	80	47	1	363262	333226
4.8	86	52	1	363263	333233
5.0	86	52	1	363264	333240
5.5	93	57	1	363267	333271
6.0	93	57	1	363268	333288
6.5	101	63	1	363269	333295
6.8	109	69	1	363270	333301
7.0	109	69	1	363271	333318
7.5	109	69	1	363272	333325
8.0	117	75	1	363274	333349
8.5	117	75	1	363276	333363
9.0	125	81	1	363277	333370
9.5	125	81	1	363278	333387
10.0	133	87	1	363279	333394
10.5	133	87	1	363281	333417
11.0	142	94	1	363282	333424
11.5	142	94	1	363283	333431
12.0	151	101	1	363284	333448
12.5	151	101	1	363285	333455
13.0	151	101	1	363286	333462



Metal drill bits HSS-G Cobalt - DIN 338 / cassettes

Description	Id. No. 4932	EAN Code 4002395
HSS-G Co drill bits (19-piece). Plastic cassette ① with Ø 1/1.5/2/2.5/3/3.5/4/4.5/5/5.5/6/6.5/7/7.5/8/8.5/9/9.5/10 mm.	352470	371297
HSS-G Co drill bits (25-piece). Plastic cassette ② with Ø 1/1.5/2/2.5/3/3.5/4/4.5/5/5.5/6/6.5/7/7.5/8/8.5/9/9.5/10/10.5/11/11.5/12/12.5/13 mm.	352471	371303



Metal drill bits HSS-G Cobalt - DIN 338/5 and 10 pack

Metal drill bits ground from solid extremely heat resistant cobalt-alloyed high speed steel produced according to DIN 338. Polished finish. Split point shaped cutting tip with 135° angle for improved centering – no center punch required. 5% Cobalt content withstands high drilling heat. Type N flute normal angle. Suitable for drilling high alloy content steels and metals with tensile strengths over 1000 N/mm² like heat and acid proof steels and stainless steel. Colour: bronze.

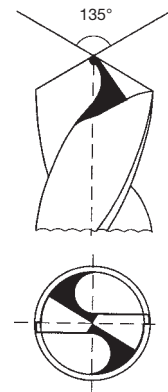

Ø mm	A mm	B mm	Quantity	Id. No. 4932	EAN Code 4002395
1.0	34	12	10	373332	349173
1.5	40	18	10	373333	349180
2.0	49	24	10	373334	349197
2.5	57	30	10	373335	349807
3.0	61	33	10	373336	349814
3.2	65	36	10	373337	349821
3.5	70	39	10	373338	349838
4.0	75	43	10	373339	349845
4.2	75	43	10	373340	349852
4.5	80	47	10	373341	349869
4.8	86	52	10	373342	349876
5.0	86	52	10	373343	349883
5.5	93	57	10	373344	349890
6.0	93	57	10	373345	347100
6.5	101	63	10	373346	347117
6.8	109	69	5	373347	347124
7.0	109	69	5	373348	347131
7.5	109	69	5	373349	347148
8.0	117	75	5	373350	347155
8.5	117	75	5	373351	347162
9.0	125	81	5	373352	347179
9.5	125	81	5	373353	347186
10.0	133	87	5	373354	347193
10.5	133	87	5	373355	347803
11.0	142	94	5	373356	347810
11.5	142	94	5	373357	347827
12.0	151	101	5	373358	347834
12.5	151	101	5	373359	347841
13.0	151	101	5	373360	347858



Contractor 50pc set

Info	Quantity	Id. No. 4932	EAN Code 4002395
<p>Contents:</p> <p>HSS-G drill bits THUNDERWEB: 1 x 2.0 mm, 2 x 2.5 mm, 2 x 3.0 mm 2 x 3.5 mm, 2 x 4.0 mm, 2 x 4.5 mm 2 x 5.0 mm, 1 x 6.0 mm</p> <p>Masonry drill bits: 1 x 4.0 mm 1 x 5.0 mm, 1 x 5.5 mm 2 x 6.0 mm, 1 x 7.0 mm 2 x 8.0 mm, 1 x 9.0 mm, 1 x 10.0 mm</p> <p>Screwdriving bits SHOCKWAVE: 25 mm length 1 x PH1, 2 x PH2 1 x PZ1, 2 x PZ2, 1 x PZ3 2 x TX15, 2 x TX20, 2 x TX25, 1 x TX30, 1 x TX40, 1 x TX50 1 x Hex 4 mm, 1 x Hex 5 mm 50 mm length 1 x PH2, 1 x PZ2, 1 x TX20</p> <p>Nut drivers SHOCKWAVE: 1 x Hex 7 mm, 1 x Hex 8 mm 1 x Hex 10 mm</p> <p>1 x magnetic bit holder SHOCKWAVE 60 mm length 1 x QUIK-LOK extension ¼" Hex 150 mm length</p>	1	352863	375219



Contractor 100pc set

Info	Quantity	Id. No. 4932	EAN Code 4002395
<p>Contents:</p> <p>HSS-R drill bits: 1 x 2.0 mm, 2 x 2.5 mm, 2 x 3.0 mm 2 x 3.5 mm, 2 x 4.0 mm, 2 x 4.5 mm 2 x 5.0 mm, 1 x 6.0 mm</p> <p>Masonry drill bits: 1 x 4.0 mm 1 x 5.0 mm, 1 x 5.5 mm 2 x 6.0 mm, 1 x 7.0 mm 2 x 8.0 mm, 1 x 9.0 mm, 1 x 10.0 mm</p> <p>Screwdriving bits: 25 mm length 2 x PH1, 4 x PH2 2 x PZ1, 4 x PZ2, 3 x PZ3 1 x TX7, 1 x TX8, 1 x TX9, 3 x TX10 4 x TX15, 4 x TX20, 4 x TX25, 2 x TX30 2 x Hex 3 mm, 2 x Hex 4 mm 2 x Hex 5 mm, 2 x Hex 6 mm 3 x SL 0.6x4.5 mm, 3 x SL 0.8x5.5 mm 3 x SL 1.0x5.5 mm, 3 x SL 1.2x6.5 mm 50 mm length 1 x PH1, 1 x PH2, 1 x PZ1, 1 x PZ2 1 x TX10, 1 x TX15, 1 x TX20, 1 x TX25</p> <p>Nut drivers: 1 x Hex 6 mm, 1 x ⅝" 1 x Hex 7 mm, 1 x Hex 8 mm 1 x Hex 10 mm, 1 x Hex 13 mm</p> <p>Wood drill bits: 1 x 3.0 mm 1 x 4.0 mm 1 x 5.0 mm 1 x 6.0 mm 1 x 7.0 mm</p> <p>1 x magnetic bit holder 60 mm length 1 x socket adapter ¼" Hex → ¼" square drive 1 x counter sink</p>	1	352864	375226



Magnetic Drilling



100% Faster

Speed and time savings are achieved due to the following factors. Firstly the annular cutter principle of only cutting material from the periphery of the hole as opposed to the twist drill which must cut the complete diameter of the hole. Secondly the benefit of two aggressive sharp angles per cutting edge help to achieve faster feed rates and lower cutting resistance.

30% More productivity

Because the annular cutter is only cutting material from the periphery of the hole.

Less motor energy and driving power is required.

The larger the drill diameter the greater the energy saving.

Longer lifetime

The annular cutters cutting edges do less work than the twist drill resulting in more holes between sharpening. Thick 6 mm body together with special tooth geometry ensures high stability and reduces to a minimum the risk of breakage due to overloading.

Speed chart

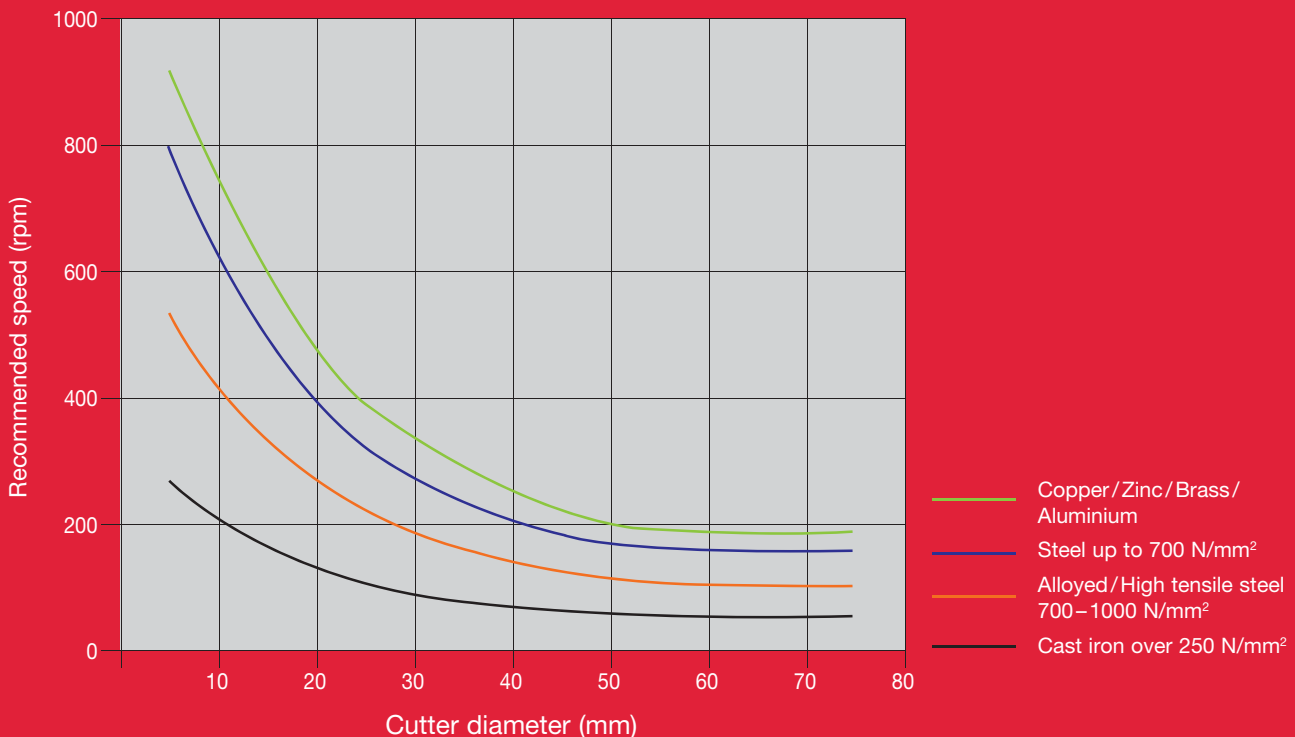

HSS annular cutters

Thick walled HSS annular cutters for increased durability and lifetime. With standard 19 mm Weldon reception. 30 or 50 mm depth of cut.

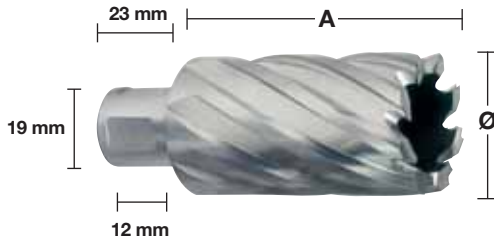

30 mm

Ø mm	A mm	Quantity	Id. No. 4932	EAN Code 4002395
12	30	1	371740	344161
13	30	1	371741	344178
14	30	1	343270	315130
15	30	1	343271	315147
16	30	1	343272	315154
17	30	1	343273	315161
18	30	1	343274	315178
19	30	1	343275	315185
20	30	1	343276	315192
21	30	1	343277	315208
22	30	1	343278	315215
23	30	1	343279	315222
24	30	1	343280	315239
25	30	1	343281	315246
26	30	1	343282	315253
27	30	1	343283	315260
28	30	1	343284	315277
29	30	1	343285	315284
30	30	1	343286	315291
31	30	1	343287	315307
32	30	1	343288	315314
33	30	1	371742	344185
34	30	1	371743	344192
35	30	1	371744	344208
36	30	1	371745	344215
37	30	1	371746	344222
38	30	1	371747	344239
39	30	1	371748	344246
40	30	1	371749	344253
41	30	1	371750	344260
42	30	1	371751	344277
43	30	1	371752	344284
44	30	1	371753	344291
45	30	1	371754	344307
46	30	1	371755	344314
47	30	1	371756	344321
48	30	1	371757	344338
49	30	1	371758	344345
50	30	1	371759	344352

50 mm

Ø mm	A mm	Quantity	Id. No. 4932	EAN Code 4002395
14	50	1	343289	315352
15	50	1	343290	315369
16	50	1	343291	315376
17	50	1	343292	315383
18	50	1	343293	315390
19	50	1	343294	315406
20	50	1	343295	315413
21	50	1	343296	315420
22	50	1	343297	315437
23	50	1	343298	315444
24	50	1	343299	315451
25	50	1	343300	315468
26	50	1	343301	315475
27	50	1	343302	315482
28	50	1	343303	315499
29	50	1	343304	315505
30	50	1	343305	315512
31	50	1	343306	315529
32	50	1	343307	315536
33	50	1	371760	344369
34	50	1	371761	344376
35	50	1	371762	344383
36	50	1	371763	344390
37	50	1	371764	344406
38	50	1	371765	344413
39	50	1	371766	344420
40	50	1	371767	344437
41	50	1	371768	344444
42	50	1	371769	344451
43	50	1	371770	344468
44	50	1	371771	344475
45	50	1	371772	344482
46	50	1	371773	344499
47	50	1	371774	344505
48	50	1	371775	344512
49	50	1	371776	344529
50	50	1	371777	344536

Ejector pin for 30 mm cutters **343308** 315321

Ejector pin for 50 mm cutters **343309** 315543

① **6pc HSS annular cutter set** **372533** 345236
 19 mm Weldon reception and ejector pin short series – 30 mm, 6 piece set Ø 14/16/18/20/22/24 mm.

System accessories - Magnetic drill stands



MD 38



1/2" x 20
48662125

Arbor and chuck
13 mm



Metal drill
bits



MDE 42/MBE 1200
Reception 1/2" x 20 UNF



1/2" x 20 UNF
4932218111

Keyed chuck
1.5–13 mm



4932371785

Oil feed
ring



1/2" x 20 UNF
19 mm Weldon
4932372781

Cutter arbor
(standard equipment)



4932371782

Oil cup
assembly



19 mm Weldon
4932371788

Oil feed
arbor

19 mm Weldon



30 mm
Cutters (Short)

4932343308

Ejector pin (30 mm)

19 mm Weldon



50 mm
Cutters (Long)

4932343309

Ejector pin (50 mm)



MDE 4-85
Reception Morse taper 3



MT 3
19 mm Weldon
4932343310

Cutter arbor
(standard equipment)



MT 3
B 16
4932117042

Chuck adaptor



MT 3
B 22
4932117044

Chuck adaptor



B 16
4932127011

Keyless chuck
3–16 mm



B 16
4932127010

Keyed chuck
1–16 mm



B 22
4932117031

Keyed chuck
5–20 mm

Metal drill bits



Metal
drill bits



4932604226

**Ejector tool for
Morse taper**



Nothing but HEAVY DUTY.™

High Performance Bi-Metal Holesaws

HOLE DOZER™

The Milwaukee® *Hole Dozer*™ is the jobsite workhorse that provides unstoppable durability through the most demanding applications.



Ø 19–37 mm



Ø 38–152 mm



Ø 152–210 mm

- Lifetime warranty against tooth breakage
- Rip guard tooth geometry provides for the most durable tooth form and best lifetime

PLUG JACK™

- Multiple leverage points to work cut material out of the holesaw for faster plug removal
 - Deepest access for thick plugs
 - Higher access for thin material
- Minimises downtime between cuts

PLUG JACK™



ALL-ACCESS SLOT

PLUG JACK™



ALL-ACCESS SLOT





Tooth design

A variable 4–6 teeth per inch tooth design with a positive 10° tooth angle provides the following benefits:

- Faster and more aggressive cut.
- Improved heat dispersion during cutting ensures that the teeth stay sharper for longer.
- Deeper curved gullets provide more efficient chip clearance preventing clogging and heat build up.
- Special shaped tooth angle has less tendency to snag on thinner materials.
- Teeth are alternate/side set to minimise binding and friction.
- Requires less feed pressure – This is achieved by the combination of aggressive tooth geometry and good chip clearance resulting in the requirement of less force during drilling.

Holesaw body

- 1.27 mm thick steel holesaw body is rigid to retain its shape but also has built in elasticity.
- Effective sawing depth is 41 mm.

Applications

- High quality manufacturing techniques ensure high rotational precision, therefore these holesaws are suitable for use both in hand and pillar drills (manual feed only).
- This high quality holesaw range is the perfect solution for cutting all types of materials:
 - Steel up to 1000 N/mm² strength
 - Stainless steel and acid resistant steel
 - Non-ferrous metals
 - Cast iron
 - Aluminium
 - Wood
 - Medium density fibreboard (MDF)
 - Gypsum plasterboard
 - Sandwich materials
 - PVC

Tooth material

- Type Matrix II premium high speed steel is used for the toothed area of the holesaw. Matrix II steel contains 8% cobalt allowing the teeth to retain the original tooth hardness even at high working temperatures when used in metal cutting applications.
- Bi-Metal construction – High speed steel teeth are laser welded onto a low alloy steel body. The teeth are then vacuum hardened to 65 HRC at a temperature of 600°C to give maximum durability and lifetime.
- Due to the high wear resistance of the Matrix II steel, these holesaws are ideal for cutting difficult and hard materials such as stainless steel and acid resistant steels as well as softer materials like wood.

Back plate design

- The back plates are constructed with thick steel thus the holes will not enlarge over time. Thick backs add strength and rigidity minimising vibrations.
- 4 drive pin holes for easier arbor location.
- Perfectly manufactured round back plate, especially important for the larger diameter holesaws.



FIXTEC arbors

① For holesaws Ø 14–30 mm

FIXTEC “twist release” quick change arbor. Prevents holesaw locking onto the arbor. Compatible to all manufacturers holesaws – no adapter required.

② For holesaws Ø 32–210 mm

The locking nut secures and locks the arbor drive plate against the back of the holesaw for a stable fit, eliminating holesaw wobble and vibration.



①



②

Hole Dozer[™] holesaws: Recommended cutting speed in RPM

Ø mm	Ø Inch	Metal up to 700 N/mm ²	Cast iron	Stainless steel & metal up to 1000 N/mm ²	Non-ferrous metal	Aluminium	Wood	MDF
14	9/16	580	400	300	790	900	1500	750
16	5/8	550	365	275	730	825	1500	750
17	11/16	500	330	250	665	750	1500	750
19	3/4	460	300	230	600	690	1500	750
20	25/32	425	280	210	560	635	1500	750
21	13/16	425	280	210	560	635	1500	750
22	7/8	390	260	195	520	585	1500	750
23	29/32	370	250	185	500	550	1500	750
25	1	350	235	175	470	525	1500	750
27	1 1/16	325	215	160	435	480	1400	700
29	1 1/8	300	200	150	400	450	1400	700
30	1 3/16	285	190	145	380	425	1400	700
32	1 1/4	275	180	140	380	410	1400	700
33	1 5/16	260	175	135	345	390	1400	700
35	1 3/8	250	165	125	330	375	1400	700
37	1 7/16	240	160	120	315	360	1400	700
38	1 1/2	230	150	115	300	345	1400	700
40	1 9/16	220	145	110	290	330	1200	600
41	1 5/8	210	140	105	280	315	1200	600
43	1 11/16	205	135	100	270	305	1200	600
44	1 3/4	195	130	95	260	295	1200	600
46	1 13/16	190	125	95	250	285	1200	600
48	1 7/8	180	120	90	240	270	1200	600
50	1 31/62	175	120	85	230	260	1200	600
51	2	170	115	85	230	255	1200	600
52	2 1/16	165	110	80	220	245	1200	600
57	2 1/4	150	100	75	200	225	1000	500
58	2 19/62	145	100	75	195	225	1000	500
59	2 5/16	145	100	75	195	225	1000	500
60	2 3/8	140	95	70	190	220	1000	500
63	2 31/64	135	90	65	180	205	900	450
64	2 1/2	135	90	65	180	205	900	450
65	2 9/16	130	85	65	175	200	800	400
68	2 11/16	125	80	60	160	185	800	400
73	2 7/8	120	80	60	160	180	800	400
76	3	115	75	55	150	170	700	350
79	3 1/8	110	70	55	140	165	700	350
83	3 1/4	105	50	40	140	155	700	350
86	3 3/8	100	45	30	130	150	500	250
89	3 1/2	95	45	30	130	145	500	250
92	3 5/8	95	60	45	120	140	500	250
95	3 3/4	90	60	45	120	135	500	250
98	3 7/8	90	60	45	120	135	500	250
102	4	85	55	40	110	130	400	200
105	4 1/8	80	55	40	110	120	400	200
111	4 3/8	80	50	40	100	120	300	150
114	4 1/2	75	50	35	100	105	300	150
121	4 3/4	75	50	35	95	95	300	150
127	5	65	45	30	90	90	200	100
133	5 1/4	60	40	25	85	85	200	100
140	5 1/2	60	40	25	85	85	200	100
146	5 3/4	55	35	25	75	75	200	100
152	6	55	35	25	75	75	200	100
160	6 5/16	50	30	25	60	60	150	75
168	6 5/8	50	30	25	55	55	150	75
177	6 31/32	45	25	25	55	55	150	75
200	7 7/8	40	25	25	50	50	100	50
210	8 9/32	40	20	25	50	50	100	50



Cutting oil Dry Cutting oil Cutting oil Turpentine Dry Dry



Speed kills!

Operating at higher speeds than those recommended will shorten the life of the holesaw and produce very inefficient cutting.



Feed Pressure:

Variables in material, work configuration should be considered. Apply sufficient feed pressure to aid good chip removal. Reduce the pressure when the holesaw becomes hot or if the teeth start to clog with material. Insufficient feed pressure will dull tooth points prematurely but too much pressure can totally destroy teeth.



Cooling Lubricant:

Cutting oil serves two purposes when sawing in metals. It cools the saw and the work piece. It reduces heat and abrasion which can shorten cutting life. It also aids re-moving swarf from the cutting surface. Using a cooling lubricant will extend the life of your holesaw by 500%.

Hole Dozer™ holesaws - A cut above the rest!







Ø mm	Ø Inch	Cutting depth mm	Id. No.	UPC Code 45242
14	9/16	41	49560002	271061
16	5/8	41	49560012	192922
17	11/16	41	49560014	193639
19	3/4	41	49560023	192632
20	25/32	41	49560024	271016
21	13/16	41	49560027	192649
22	7/8	41	49560032	192878
24	15/16	41	49560037	192885
25	1	41	49560043	192526
27	1 1/16	41	49560047	192892
29	1 1/8	41	49560052	192939
30	1 3/16	41	49560057	192946
32	1 1/4	41	49560062	192977
33	1 5/16	41	49560067	192984
35	1 3/8	41	49560072	192991
37	1 7/16	41	49560077	193028
38	1 1/2	41	49560082	193035
40	1 9/16	41	49560087	193042
41	1 5/8	41	49560092	193073
43	1 11/16	41	49560097	193080
44	1 3/4	41	49560102	193097
46	1 13/16	41	49560107	193127
48	1 7/8	41	49560112	193134
50	1 31/62	41	49560113	271023
51	2	41	49560117	193141
52	2 1/16	41	49560122	193172
54	2 1/8	41	49560127	193189
57	2 1/4	41	49560132	193196
59	2 5/16	41	49560137	193226
60	2 3/8	41	49560142	193233
64	2 1/2	41	49560147	193240
65	2 9/16	41	49560153	193271
67	2 5/8	41	49560158	193288
68	2 11/16	41	49560159	271030
70	2 3/4	41	49560163	193295
73	2 7/8	41	49560167	193325
76	3	41	49560173	193332
79	3 1/8	41	49560177	193349
83	3 1/4	41	49560183	193370
86	3 3/8	41	49560187	193387
89	3 1/2	41	49560193	193394
92	3 5/8	41	49560197	193431
95	3 3/4	41	49560203	193448
98	3 7/8	41	49560207	193479
102	4	41	49560213	193486
105	4 1/8	41	49560217	193493
111	4 3/8	41	49560227	193530
114	4 1/2	41	49560233	193547
121	4 3/4	41	49560237	193578
127	5	41	49560243	193585
133	5 1/4	41	49560244	271078
140	5 1/2	41	49560247	193592
152	6	41	49560253	193622
160	6 5/16	38	4932399885	4002395365395
168	6 5/8	38	4932399886	4002395365401
177	6 31/32	38	4932399887	4002395365418
200	7 7/8	38	4932399888	4002395365425
210	8 3/32	38	4932399889	4002395365432



Hole Dozer[™] holesaw sets

Description	Id. No.	UPC Code 45242	
<p>7pc Holesaw set Contents: 7 pcs. Holesaws: 19, 22, 25, 29, 32 mm. ① Arbor – for holesaws Ø 14 – 30 mm (Id. No. 49567010). Spacer and adaptor. 1/8" Hex allen key.</p>	49224083	310760	
<p>10pc Holesaw set Contents: 10 pcs. Holesaws: 25, 32, 40, 54, 68, 76 mm. ② Arbor – for holesaws Ø 14 – 30 mm (Id. No. 49567010). Arbor – for holesaws Ø 32 – 152 mm (Id. No. 49569100). 2x Pilot drill bits, 1/8" Hex allen key.</p>	49224201	348091	
<p>14pc Holesaw set Contents: 14 pcs. Holesaws: 19, 22, 25, 29, 32, 35, 38, 44, 51, 57 mm. ③ Arbor – for holesaws Ø 14 – 30 mm (Id. No. 49567010). Arbor – for holesaws Ø 32 – 152 mm (Id. No. 49569100). 2x Pilot drill bits, 1/8" Hex allen key.</p>	49224152	271047	
<p>17pc Holesaw set Contents: 17 pcs. Holesaws: 20, 22, 25, 32, 40, 44, 51, 57, 64, 65, 67, 68, 76 mm. ④ Arbor – for holesaws Ø 14 – 30 mm (Id. No. 49567010). Arbor – for holesaws Ø 32 – 152 mm (Id. No. 49569100). 2x Pilot drill bits, 1/8" Hex allen key.</p>	49224102	271054	
<p>Holesaw kit box Contents: ⑤ Arbor with pilot drill (Id. No. 49567010). Arbor with pilot drill (Id. No. 49569100). 2x Pilot drill bits, 1/8" allen key (Id. No. 49960060).</p>	4932430327	4002395 379880	

System accessories - Hole Dozer™ holesaws

Description	For hole-saws Ø mm	Reception mm	Holesaw thread	Id. No.	UPC Code 45242	
① FIXTEC "Twist Release" quick change arbor	Ø 14–30	Hex 9.5	1/2" x 20	49567210	200320	
② Arbor	Ø 14–30	Hex 9.5	1/2" x 20	49567010	200177	
③ Arbor	Ø 32–210	Hex 9.5	5/8" x 18	49567250	225798	
④ Arbor	Ø 32–210	Hex 11	5/8" x 18	49569100	200832	
⑤ Extension – 330 mm long for 9.5 mm Hex reception arbors.	–	Hex 9.5	–	48284008	225811	
⑥ Extension – 300 mm long for 11 mm Hex reception arbors.	–	Hex 11	–	48284006	122516	
⑦ Pilot drill bit Fits to all arbors Ø 6 mm and 89 mm length.				49568010	200450	
Allen key 1/8" for all arbors.				49960060	221455	
Grub screw for arbors.				06832712	4002395 874354	

Diamond Plus™ wet/dry drill bits and holesaws

Diamond grit edge drills and holesaws have been specially developed for professionals that need to drill in extremely hard materials such as porcelain/gres/quarry tiles, cast iron or fibreglass where it is increasingly difficult to drill with conventional holesaws. These holesaws guarantee excellent performance and superior life time even in the hardest of materials.

Water starved!: These holesaws only require limited water supply unlike conventional diamond drills that require a continuous flow of water. Just dip the drill bit or holesaw into water at the start of each hole to be cut and thereafter every 5 second cut duration.

Clean holes: Drills clean, precise holes without any perimeter scratches.

Lifetime: To ensure long lifetime, we use high grade diamond for fast cutting and a superior brazed bond matrix to give best durability.

Durability: Tough alloy body which does not bend or distort easily.

Easy slug ejection: Offset slug ejection slots for greater leverage when removing tight slugs.

Versatile: Can be used either on angle grinders with relevant adaptor or with a drill.



Ø mm	Reception	Quantity	Id. No.	UPC Code 45242
Drills				
5	1/4" Hex	1	49560503	223732
6	1/4" Hex	1	49560505	223749
8	1/4" Hex	1	49560507	223756
① 10	1/4" Hex	1	49560509	223763
12	1/4" Hex	1	49560511	223770
15	1/4" Hex	1	49560513	223787
20	1/4" Hex	1	49560515	223794
25	1/4" Hex	1	49560517	223800
Holesaws				
22	1/2" x 20	1	49565605	308439
29	1/2" x 20	1	49565615	308446
32	5/8" x 18	1	49565620	308453
② 35	5/8" x 18	1	49565625	308460
38	5/8" x 18	1	49565630	308477
44	5/8" x 18	1	49565640	308491
51	5/8" x 18	1	49565645	308507
68	5/8" x 18	1	49565664	337835

Application areas

Ceramic tiles – all types hard and soft:
Porcelain/Gres/Granite/Quarry/Terrazzo/Artificial stone/Terracota/Agglomerate/Glazed

Cast iron

Fibreglass/GRP

(Glass reinforced plastic)/Perspex



Description	For holesaws Ø	Shank reception	Holesaw thread	Quantity	Id. No.	UPC/EAN Code 4002395
Arbor	14–30 mm	9.5 mm Hex	1/2" x 20	1	49567010	45242200177
Arbor	32–210 mm	9.5 mm Hex	5/8" x 18	1	49567250	45242225798
Grinder adaptor	22–29 mm	M14	1/2" x 20	1	4932430464	381258
Grinder adaptor	32–68 mm	M14	5/8" x 18	1	4932430465	381265

How to use on an angle grinder

- Screw the grinder adaptor M14 to the holesaw and tighten firmly with a spanner. Then apply the spindle lock on the angle grinder and fit the adaptor directly onto the spindle, tighten firmly with a spanner.
- If the tile is not fitted to a wall or floor ensure it is secured firmly with a clamp.
- Wear safety glasses and gloves.
- Dip the holesaw tips into water.
- Switch on angle grinder to full speed. Slowly approach the tile with the holesaw at a 20–30° angle with light pressure to avoid skating on the tile. Once the holesaw starts to cut into the tile and forms a groove gradually raise the holesaws so that it is horizontal with the tile.
- Every 5 seconds dip the holesaw in water.
- Apply light pressure and a oscillating circular motion during cutting to maximise tool life.

Professional water cooling system

- Water feed system with water regulator to control water flow.
- Easy fixing and removal from surfaces due to vacuum fixing.

Description	Quantity	Id. No. 4932	EAN Code 4002395
Professional water cooling system includes: ① – Water pressure tank with 1 litre capacity – Water hose – Water regulation unit	1	352330	369898
② Drilling guide for drills Ø 5–15 mm.	1	352331	369904
Drilling guide for drills/holesaws Ø 19–68 mm.	1	352332	369911



SHOCKWAVE IMPACT DUTY TM

IMPACT HOLESAWS



Optimised for use with cordless tools



- ① Thin wall
 - 8 TPI = smooth burr free holes
 - 0.6 mm thick = less resistance
 - > up to 40% faster
- ② Shallow cup optimised for drilling thin metal
- ③ 8% Cobalt Bi-Metal for best durability and lifetime
- ④ Ejection spring auto ejects slugs
- ⑤ Stop shoulder prevents over drilling
- ⑥ 1/4" Hex shank = impact driver compatible

Suitability

Max. 2 mm steel, aluminium and stainless steel (max. 1.5 mm)

Shockwave impact holesaws

NEW

	Ø mm	Quantity	Id. No.	UPC/EAN Code 45242
	19	1	49569805	321094
	22	1	49569810	321100
	25	1	49569815	321117
①	29	1	49569820	321124
	32	1	49569825	321131
	35	1	49569830	321148
	38	1	49569835	321155
②	3 pcs Shockwave impact set contains: Ø 22/29/35 mm		49224800	321162
	Ejection spring and grub screw		4932430466	4002395381272
	Pilot drill bit with arbor		4932430477	4002395381388



M12/M18 Dust extraction system attachments

Description	M18 CDEX/ M18/28 CPDEX	M12 DE Qty.	Id. No.	UPC/EAN Code 4002395
① Drilling nozzle	●	● 2	49902301	337279
② Filter	●	● 3	49902306	299454
③ Crevice nozzle		● 1	49902325*	297603
④ M12 Dustbox 3-piece set with filter box, filter, box lid		● 1	49902340	299461
⑤ M18 & M28 Dustbox with filter box, filter	●		49902342	341948
⑥ M12DEAC – Dust thru-box to allow connection of the M12DE to an independent dust extraction/vacuum cleaner. Outlet nozzle: Ø 37 mm outside/Ø 32 mm inside.			4932430479	381401



Side handles

Description	Qty.	Id. No. 4932	EAN Code 4002395
① Side handle with depth gauge for all drills and percussion drills with gear neck diameter 43 mm.	1	373725	352647
② Side handle with depth gauge for all drills and percussion drills with a short gear neck (13 mm) of diameter 43 mm.	1	364149	342198



Dust extraction

Aprašymai	Qty.	Id. No. 4932	EAN Code 4002395
Dust collection ring ① For collecting dust when overhead drilling. Suitable for Ø 5–8 mm.	1	265320	302741
Cloth filter bag for PHE 26 RA/PPH 26 RA/SB2E 20 RA.	1	346182	313273
Xtractor For dust collection on the wall or when overhead drilling. Maximum diameter drill bit Ø 28 mm. Fits to all industrial dust extraction units (universal reception Ø 26–41 mm).	1	430446	381074
Drilling shroud – PHDE72 For drilling and coring from Ø 6–72 mm. Brush insert to improve suction and extraction. ③ Brushes to be removed for coring applications. Outlet nozzle: Ø 37 mm outside/Ø 32 mm inside. Replacement sealing lips (2 pcs): 4931448564 Replacement brush: 4931448565	1	430480	381418



Universal right angle drill attachment

- Converts Milwaukee® HDE 13 RQD straight drill to angle drill.
- Used extensively for drilling between joists or in tight corners.
- Head and handle swivel 360°
- Provides two speeds: 1. Low: speed decreases by 30% torque increases by 50%.
2. High: speed increases by 50%.

Description	Quantity	Id. No.	UPC Code 45242
Right angle drill attachment	1	48062871	088812

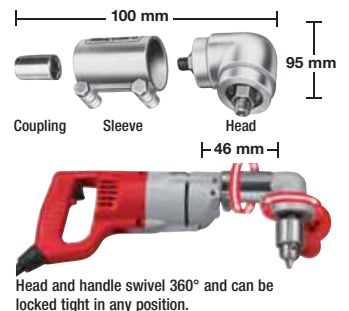

QUIK-LOK cables

Length m	Country version	Id. No. 4932	EAN Code 4002395	Length m	Country version	Id. No. 4932	EAN Code 4002395
4 m	EU	373502	351725	4 m	GB 240	373508	351787
10 m	EU	373503	351732	4 m	GB 110	373510	351800
4 m	CH	373504	351749	6 m	EU	364483 ¹	337620
4 m	AUS	373506	351763	QUIK-LOK cable repair kit		4931380758	714551





Screwdriving bits



① The ribs are cold formed to exact specification ensuring reduced wear from slippage. The tip is subjected to a special hardening process with temperatures up to 870°C. The outcome is a bit with a hardness of 60 HRC. This extra hard tip ensures extra long life under constant use.

② The body is manufactured from the highest quality S2 european steel.

③ The sign of "Quality". All bits are laser marked with the Milwaukee® logo and tip reception for easy identification.

Info	Tool receptions with 1/4" hexagonal shaft Size Length mm		Quantity	Id. No. 4932	EAN Code 4002395
Phillips 	PH 1	25	25	399586	362363
	PH 2	25	25	399587	362370
	PH 3	25	25	399588	362387
Pozidrive 	PZ 1	25	25	399589	362394
	PZ 2	25	25	399590	362400
	PZ 3	25	25	399591	362417
Torx 	TX 10	25	25	399594	362448
	TX 15	25	25	399595	362455
	TX 20	25	25	399596	362462
	TX 25	25	25	399597	362479
	TX 30	25	25	399599	362493
	TX 40	25	25	399600	362509

Trade case

Description	Quantity	Id. No. 4932	EAN Code 4002395
Contents: Screwdriving bits 25 mm length PH 1 x 2 / PZ 1 x 2 / TX 10 x 2 / TX 25 x 3 PH 2 x 3 / PZ 2 x 3 / TX 15 x 2 / TX 30 x 2 ① PH 3 x 2 / PZ 3 x 2 / TX 20 x 3 / TX 40 x 2 Screwdriving bits 50 mm length PH 1 x 1 / PZ 1 x 1 / TX 20 x 1 PH 2 x 1 / PZ 2 x 1 / TX 25 x 1 Magnetic bit holder with 1/4" Hex reception x 1 Counter display ② (contains 6x screwdriving bit set – 35-piece 4932352068)	1	352068	367214
② (contains 6x screwdriving bit set – 35-piece 4932352068)	1	352063	366699



Magnetic bit holders

Description	Quantity	Id. No. 4932	EAN Code 4002395
Magnetic bit holder ① with quick release clutch. Total length 58 mm.	1	373483	351060
Magnetic bit holder ② for drywall.	1	430179	378401



Compact screwdriving bit cassettes

This high quality cassette aimed at the professional user is available in 3 different assortments.

- Slimline pocket design: 110 mm x 65 mm x 15 mm.
- Secure latch system: easy opening and safe closing.
- Extra side compartment accepts either 50 mm screwdriving bits or drill bits.
- Front window to protect bits from dust.
- High quality screwdriving bits with hardness of 60 HRC and ¼" Hex reception.
 - 25 mm bits manufactured according to DIN 3126 – C 6.3.
 - 50 mm bits are manufactured according to DIN 3126 – E 6.3.
- HSS-G Metal drill bits are ground from one piece of solid high speed steel according to DIN 1412 C.
 - Split point shaped cutting tip with 135° angle for improved centering.
 - Type N flue design for fast chip removal.
 - Reception manufactured according to DIN 3126 – E 6.3.
 - Suitable for drilling in steel, cast iron, alloyed and non alloyed material up to 900 N/mm².
- Magnetic bit holder with quick release clutch.

Description	Quantity	Id. No. 4932	EAN Code 4002395	
12pc compact screwdriving bit set 25 mm: SL 0.8x5.5 mm x 1 25 mm: PH1 x 1 / PH2 x 2 / PH3 x 1 ① 25 mm: PZ1 x 1 / PZ2 x 2 / PZ3 x 1 50 mm: PH2 x 1 50 mm: PZ2 x 1 Magnetic bit holder with quick release clutch	1	399513	361601	① 
12pc compact screwdriving bit set TITANIUM 25 mm: PH2 x 1 25 mm: PZ1 x 1 / PZ2 x 1 / PZ3 x 1 ② 25 mm: TX15 x 1 / TX20 x 1 / TX25 x 1 / TX30 x 1 / TX40 x 1 HSS-G metal drill bit: 3.0 mm x 1 / 5.0 mm x 1 Magnetic bit holder with quick release clutch	1	399514	361618	② 
12pc compact screwdriving bit set 25 mm: SL 0.8x5.5 mm x 1 25 mm: PH1 x 1 / PH2 x 2 / PH3 x 1 ③ 25 mm: TX10 x 1 / TX15 x 1 / TX20 x 1 / TX25 x 1 HSS-G metal drill bit: 3.3 mm x 1 / 4.2 mm x 1 Magnetic bit holder with quick release clutch	1	399516	361632	③ 
Screwdriving bit set: 27pc robust and compact with an extra big latch. PH1 x 2 / PH2 x 2 / PH3 x 1 ④ PZ1 x 2 / PZ2 x 4 / PZ3 x 2 TX10 x 2 / TX15 x 3 / TX20 x 3 TX25 x 3 / TX30 x 1 / TX40 x 1 Magnetic bit holder with quick release clutch	1	352747	374052	④ 

SHOCKWAVE IMPACT DUTY™

Shockwave Impact Duty™ screwdriving bits

Designed for use with Impact Drivers the Shockwave Impact Duty™ accessory line is not only ideal for heavy duty impact applications, but also delivers a full system solution for all the user's drilling and fastening needs.

Shock Zone Geometry – Designed to Flex.

Shock Zone reduces stress at the tip resulting in less tip breakages.



The combination of the Shock Zone design and special heat treatment absorbs impacts and allows the bit to flex with spring like action.

Compression forged tip provides the best fit with screw head, reducing cam out and stripping, resulting in outstanding lifetime.

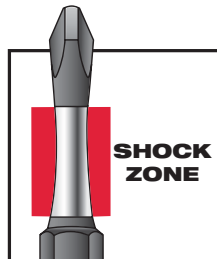
Custom engineered steel – Milwaukee® custom metal formula makes the Shockwave bits more resistant to shock from impacting.



- ① 25 mm ¼" Hex – DIN 3126 – C 6.3
- ② 50 mm ¼" Hex – DIN 3126 – E 6.3
- ③ 90 mm ¼" Hex – DIN 3126 – E 6.3

Reception	Size	Length mm	Quantity	Packaging	Id. No. 4932	EAN Code 4002395
	PH 1	25	2		352430	370894
		90	1		352591	372492
	PH 2	25	2		352431	370900
		25	25		352551	372096
		25	250 (10x 352551)		352704	373628
		50	1		352432	370917
		50	10		352975	376322
		50	100 (10x 352975)		352979	373360
	PH 3	90	1		352592	372508
		25	2		352433	370924
50		1		352434	370931	
		90	1	352593	372515	
	PZ 1	25	2		352435	370948
		25	25		352552	372102
		90	1		352594	372522
	PZ 2	25	2		352436	370955
		25	25		352553	372119
		25	250 (10x 352553)		352705	373635
		50	1		352437	370962
		50	10		352976	376339
		50	100 (10x 352976)		352980	376377
	PZ 3	90	1		352595	372539
		25	2		352438	370979
		25	25		352554	372126
			50	1	352439	370986

Blister



Storage container



Counter display



Reception	Size	Length mm	Quantity	Packaging	Id. No. 4932	EAN Code 4002395
Torx 	TX 10	25	2		352598	372560
	TX 15	25	2		352440	370993
	TX 20	25	2		352441	371006
		25	25		352555	372133
		25	250 (10x 352555)		352706	373642
		50	1		352442	371013
		50	10		352977	376346
		50	100 (10x 352977)		352981	376384
		90	1		352596	372546
	TX 25	25	2		352443	371020
		25	25		352556	372140
		25	250 (10x 352556)		352707	373659
		50	1		352444	371037
		50	10		352978	376353
		50	100 (10x 352978)		352982	376391
		90	1		352597	372553
	TX 30	25	2		352445	371044
		25	25		352557	372157
		25	250 (10x 352557)		352708	373666
		50	1		352985	376421
TX 40	25	2		352599	372577	
	25	25		352709	373673	
	25	250 (10x 352709)		352983	376407	
	50	1		352986	376438	
TX 50	25	2		352600	372584	
	25	20		352710	373680	
	25	250 (10x 352710)		352984	376414	
Hex 	Hex 4 mm	25	2		352446	371051
	Hex 5 mm	25	2		352447	371068
Slotted 	SL 0.6 x 4.5	25	2		352601	372591
	SL 0.8 x 5.5	25	2		352602	372607
	SL 1.2 x 6.5	25	2		352603	372614

Blister



Storage container



Counter display



SHOCKWAVE IMPACT DUTY™

Shockwave Impact Duty™ sets

Info	Pack Quantity	Order Quantity	Id. No.	EAN Code
			4932	4002395
15 pc Shockwave puck set				
① Display (contains 10x 15pc puck set) Contents: Shockwave Impact Duty™ screwdriving bits: 15x25 mm length 1x PH1 / 2x PH2 1x PZ1 / 2x PZ2 / 1x PZ3 1x TX10 / 2x TX15 / 2x TX20 / 1x TX25 / 1x TX30 1x magnetic bit holder 60 mm length Available only as display	10	1	352605	372638
28 pc Shockwave bits & nut drivers set				
Contents: Shockwave Impact Duty™ screwdriving bits: 18x25 mm length 1x PH1 / 3x PH2 / 2x PH3 1x PZ1 / 3x PZ2 / 2x PZ3 1x TX15 / 1x TX20 / 1x TX 25 / 1x TX30 1x Hex 4 mm / 1x Hex 5 mm ② 6x50 mm length 1x PH2 / 1x PH3 1x PZ2 / 1x PZ3 1x TX20 / 1x TX25 3x Shockwave Impact Duty™ magnetic nut drivers 48 mm length 1x Hex 7 mm / 1x Hex 8 mm / 1x Hex 10 mm 1x magnetic bit holder 60 mm length	1	1	352455	317143
③ Counter display (contains 6x 28pc set 4932352455)	6	1	352456	371150
30 pc Shockwave compact drill & drive set				
Contents: 4x Shockwave Impact Duty ¼" Hex drill bits: Ø 3/4/5/6 mm Shockwave Impact Duty™ screwdriving bits: 19x25 mm length 1x PH1 / 2x PH2 / 1x PH3 ④ 1x PZ1 / 4x PZ2 / 1x PZ3 1x TX15 / 2x TX20 / 2x TX25 2x TX30 / 1x TX40 / 1x TX 50 6x50 mm length 1x PH2 / 2x PZ2 1x TX15 / 1x TX20 / 1x TX25 1x magnetic bit holder 60 mm length	1	1	352894	375523
⑤ Counter display (contains 6x 30pc set 4932352894)	6	1	352895	375530
33 pc Shockwave bits & nut drivers set - Counter display				
Contents: Shockwave Impact Duty™ screwdriving bits: 24x25 mm length 1x PH1 / 2x PH2 / 1x PH3 2x PZ1 / 3x PZ2 / 2x PZ3 2x TX10 / 2x TX15 / 3x TX20 / 2x TX25 / 2x TX30 / 1x TX40 / 1x TX50 ⑥ 5x50 mm length 1x PH2 / 1x PZ2 1x TX15 / 1x TX20 / 1x TX25 3x Shockwave Impact Duty™ magnetic nut drivers 48 mm length 1x Hex 7 mm / 1x Hex 8 mm / 1x Hex 10 mm 1x magnetic bit holder 60 mm length	6	6	430813	384747



Shockwave Impact Duty™ sets

NEW

Info	Pack Quantity	Order Quantity	Id. No.	EAN Code
48 pc Shockwave drill & drive set - Counter display			4932	4002395
<p>Contents:</p> <p>Shockwave Impact Duty™ screwdriving bits:</p> <p>32x25 mm length 2x PH1 / 2x PH2 / 1x PH3 2x PZ1 / 3x PZ2 / 1x PZ3 3x TX10 / 3x TX15 / 3x TX20 / 3x TX25 / 3x TX30 / 1x TX40 1x Hex 4 mm / 1x Hex 5 mm 1x SL 0.6x4.5 / 1x SL 0.8x5.5 / 1x SL 1.2x6.5</p> <p>① 8x50 mm length 1x PH1 / 1x PH2 1x PZ1 1x TX10 / 1x TX15 / 1x TX20 / 1x TX 25 / 1x TX30</p> <p>3x90 mm length 1x PZ2 1x TX20 / 1x TX25</p> <p>1x magnetic bit holder 60 mm length 4x Shockwave Impact Duty ¼" Hex drill bits: Ø 3/4/5/6 mm</p> <p>Minimum order quantity = 6 pcs. Orders > 6 pcs must be ordered in multiples of 6 (i.e. 6, 12, 18).</p>	6	6	430580	382415



56 pc Shockwave drive set - Counter display				
<p>Contents:</p> <p>Shockwave Impact Duty™ screwdriving bits:</p> <p>48x25 mm length 2x PH1 / 3x PH2 / 1x PH3 3x PZ1 / 4x PZ2 / 2x PZ3 3x TX10 / 3x TX15 / 4x TX20 / 4x TX25 / 4x TX30 / 3x TX40 / 2x TX50 2x Hex 4 mm / 2x Hex 5 mm 2x SL 0.6x4.5 / 2x SL 0.8x5.5 / 2x SL 1.2x6.5</p> <p>② 7x 50 mm length 1x PH2 1x PZ1 / 1x PZ2 1x TX10 / 1x TX15 / 1x TX20 / 1x TX 25</p> <p>1x magnetic bit holder 60 mm length</p> <p>Minimum order quantity = 6 pcs. Orders > 6 pcs must be ordered in multiples of 6 (i.e. 6, 12, 18).</p>	6	6	430581	382422



40 pc Shockwave drill & drive set - Counter display				
<p>Contents:</p> <p>Shockwave Impact Duty™ screwdriving bits:</p> <p>25x25 mm length 1x PH1 / 2x PH2 1x PZ1 / 3x PZ2 2x TX10 / 2x TX15 / 3x TX20 / 2x TX25 / 2x TX30 / 1x TX40 / 1x TX50 1x Hex 4 mm / 1x Hex 5 mm 1x SL 0.6x4.5 / 1x SL 0.8x5.5 / 1x SL 1.2x6.5</p> <p>③ 8x50 mm length 1x PH2 1x PZ1 / 1x PZ2 1x TX10 / 1x TX15 / 1x TX20 / 1x TX 25 / 1x TX30</p> <p>1x magnetic bit holder 60 mm length 1x magnetic bit holder 152 mm length 3x Shockwave Impact Duty™ ¼" Hex drill bits: Ø 3/4/5mm 2x Shockwave Impact Duty™ magnetic nut drivers 48 mm length 1x Hex 8 mm / 1x Hex 10 mm</p> <p>Minimum order quantity = 6 pcs. Orders > 6 pcs must be ordered in multiples of 6 (i.e. 6, 12, 18).</p>	6	6	430582	382439



SHOCKWAVE IMPACT DUTY™

Shockwave Impact Duty™ drive guide cassettes

- Slimline pocket design
- Drive Guide bit holder with extendable sleeve to hold long screws secure. Up to 110 mm total length.
- Front loading screwdriver handle.
- Metal wire stripper for Ø 0.75 / 1.0 / 1.5 / 2.5 mm².
- Wire loop maker up to 5 mm².



Info	Pack Quantity	Order Quantity	Id. No. 4932	EAN Code 4002395
12 pc Shockwave drive guide set 1				
Contents: 1 x PH2 1 x PZ1 / 2 x PZ2 / 1 x PZ3 1 x TX20 / 1 x TX25 1 x SL 0.6 x 4.5 mm / 1 x SL 0.8 x 5.5 mm 1 x Hex 4 / 1 x Hex 5 1 x drive guide bit holder 76 mm length	12	1	352940	375981
① Counter display (contains 10x 12pc set 4932352940)	10	1	352942	376001

①



12 pc Shockwave drive guide set 2				
Contents: 1 x PH2 1 x PZ1 / 2 x PZ2 / 1 x PZ3 1 x TX15 / 1 x TX20 / 2 x TX25 / 1 x TX30 / 1 x TX40 1 x drive guide bit holder 76 mm length	12	1	352941	375998
② Counter display (contains 10x 12pc set 4932352941)	10	1	352943	376018

②



1/2" Sockets

- **Impact duty (Chrome-Molybdenum) steel** is high quality alloy steel which provides ultimate strength and durability.
- **Best fitting** thanks to 6 gripping points.
- **Recessed corners allow torque to be transferred across the flats of the socket** rather than producing stress on the points or corners.
- **Thin wall construction** provides access to tight spaces.
- **Deep wall construction provides clearance for protruding bolts.**
- **Laser etched size markings** for easy identification and won't wear off.

A	B mm	C mm	D mm	E mm	F mm	Quantity	Id. No. 4932	EAN Code 4002395
1/2"	8	78	12	15	21.8	1	352847	375059
1/2"	10	78	12	17	21.8	1	352848	375066
1/2"	11	78	12	18	21.8	1	352849	375073
1/2"	12	78	12	19	21.8	1	352850	375080
1/2"	13	78	12	20	23.8	1	352851	375097
1/2"	14	78	15	22	23.8	1	352852	375103
1/2"	16	78	15	23.8	23.8	1	352853	375110
1/2"	17	78	18	25.8	25.8	1	352854	375127
1/2"	19	78	21	27.8	27.8	1	352855	375134
1/2"	21	78	24	29.8	29.8	1	352856	375141
1/2"	24	78	24	33.8	33.8	1	352857	375158
1/2"	27	78	24	37.8	37.8	1	352858	375165
1/2"	30	78	24	41.8	38	1	352859	375172
1/2"	32	78	24	43.8	38	1	352860	375189

① **10 piece Shockwave Impact Duty™ 1/2" sockets set** 1 352861 375196
 Contents: 8 / 10 / 11 / 12 / 13 / 14 / 16 / 17 / 19 / 21 mm.

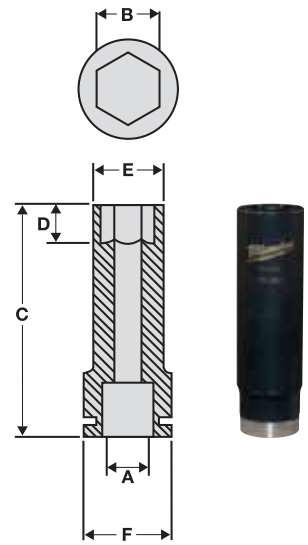

1/4" Sockets

Description	Quantity	Id. No. 4932	EAN Code 4002395
-------------	----------	--------------	------------------

20 piece Shockwave Impact Duty™ 1/4" socket set
 Contents:
 12 x 1/4" sockets: 4 / 4.5 / 5 / 5.5 / 6 / 7 / 8 / 9 / 10 / 11 / 12 / 13 mm. 50 mm total length.
 ① 6 x screwdriving bits 25 mm length: PH2, PZ2, TX 15, TX20, TX25, TX30
 1 x socket adaptor 1/4" Hex → 1/4" square drive
 1 x bit adaptor 1/4" square (F) → 1/4" Hex.
 Magnetic bit holder for screwdriving bits.

1 352862 375202

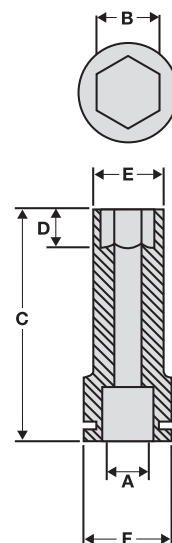

A	B mm	C mm	D mm	E mm	F mm
1/4"	4,0	50	3	7.7	12.8
1/4"	4,5	50	3,5	8	12.8
1/4"	5	50	4	8.8	12.8
1/4"	5,5	50	4,5	9.5	12.8
1/4"	6	50	6	9.8	12.8
1/4"	7	50	6	11.4	12.8
1/4"	8	50	7.5	12.5	12.8
1/4"	9	50	7.5	13.8	13.8
1/4"	10	50	9	14.3	14.3
1/4"	11	50	11	16.8	16.8
1/4"	12	50	12	17.8	17.8
1/4"	13	50	12	18.8	18.8



SHOCKWAVE IMPACT DUTY TM

Magnetic bit holder

Custom engineered steel and heat treatment for maximum strength and flexibility.
Solid construction withstands abuse in impact applications.
Strong magnetic tip for secure grip.

Description	Total length mm	Pack quantity	Order quantity	Id. No. 4932	UPC/EAN Code 4002395
Magnetic bit holder					
① with 1/4" Hex reception (DIN 3126 – E 6.3).	60	1	1	352406	370658
100 pcs bulk jar					
② Orders are only possible in multiples of 100 pcs (i.e. 200, 300...). Minimum order quantity is 100 pcs.	60	100	100	430478	381395
③ 					
④ 					
Magnetic bit holders – long series					
with 1/4" Hex reception and C ring for extra bit hold (DIN 3126 – E 6.3).					
③	152	1	1	48324511	45242301980
④	305	1	1	48324512	45242301997



Magnetic nut drivers

Custom engineered steel and heat treatment for maximum strength and extreme durability.
Strong magnetic tip for secure grip.
 Reception: 1/4" Hex (DIN 3126 – E 6.3). Very suitable for high torque and impact applications.

Size mm AF (Across Flats)	For anchor rod thread size	Length mm	Quantity	Id. No. 4932	EAN Code 4002395
5.5	M3	65	1	352536	371945
6.0	M3.5	65	1	352537	371952
1/4"	–	65	1	352538	371969
7.0	M4	65	1	352539	371976
5/16"	–	65	1	352540	371983
8.0	M5	65	1	352541	371990
3/8"	–	65	1	352542	372003
10	M6	65	1	352543	372010
12	M7	65	1	352544	372027
13	M8	65	1	352545	372034
17	M10	65	1	352546	372041
① 5 piece Shockwave Impact Duty™ nut driver set			1	352822	374809
Contents: Ø 7/8/10/12/13 mm.					



Socket and bit adaptors

Description	Total length mm	Quantity	Id. No.	EAN Code 4002395
Socket adaptor				
① 1/4" Hex → 1/4" square drive (DIN 3126 – E 6.3)	50	1	48325030	195039
Socket adaptor				
② 1/4" Hex → 1/2" square drive (DIN 3126 – E 6.3)	50	1	48325032	195046
Bit adaptor				
③ 1/2" square → 1/4" F. To accept screwdriving bits.	50	1	48034410	195015



Metal drill bits HSS Ground

Drill bit quality: high quality high speed steel ground from solid.
 Tip geometry: split point DIN 1412 C. Point angle: 135°.
 Flute: Thunderweb design. Reception: 1/4" Hex (DIN 3126 – E 6.3).
 Surface/Colour: black oxide. Right hand cutting edge.
 Application: suitable for drilling in steel, cast iron, alloyed and non-alloyed material up to 900 N/mm² and wood/plastics.

Thunderweb parabolic shaped web is characterised by larger web cross section for extra strength. Accepts higher feed pressure and torque for longer lifetime.

Thunderweb flute is an open flute with flatter twist angle for smaller chippings, ideal for drilling harder steels ie. stainless steel. Ejects hot chips rapidly, dissipates heat better increasing lifetime.

Ø mm	A mm	B mm	Quantity	Id. No. 4932	EAN Code 4002395
3	70	23	1	352448	371075
3.2	70	23	1	352606	372645
4	80	32	1	352449	371082
4.8	90	29	1	352607	372652
5	90	29	1	352450	371099
6	93	32	1	352451	371105
7	96	35	1	352452	371112
8	96	35	1	352453	371129
① 6 piece Shockwave Impact Duty™ set with Ø 3/4/5/6/7/8 mm.			1	352454	371136

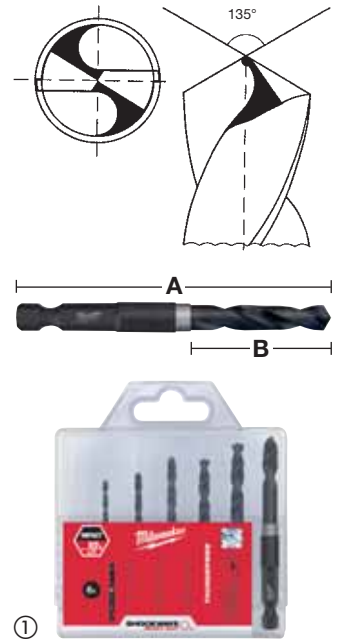

KNUCKLE™

Offset attachment for heavy duty impact applications

- Impact rated. Can be used with both cordless and impact drills.
- Very compact offset attachment.
- Ideally suited to working in confined and limited spaces.
- Solid metal construction to absorb impact action.
- 0° and 30° positions.
- 1/4" Hex shank fits directly into the chuck preventing slippage.
- Suitable for use with 1/4" Hex impact drivers up to 180 Nm torque.



* Height when 30° tilted 40 mm



Description	Quantity	Id. No. 4932	EAN Code 4002395
Knuckle™ 1 x Knuckle™ 1 x PH1 / 2 x PH2 1 x PZ1 / 2 x PZ2 / 1 x PZ3 1 x TX15 / 1 x TX20 / 1 x TX25	1	352938	375967
① Counter display (contains 10x 11pc set 4932352938)	1	352939	375974



OSD2 - Offset Screwdriver/drill

The **OSD2 screwdriver/drill angle attachment** is the ideal solution for all screwdriving and drilling applications in restricted areas.

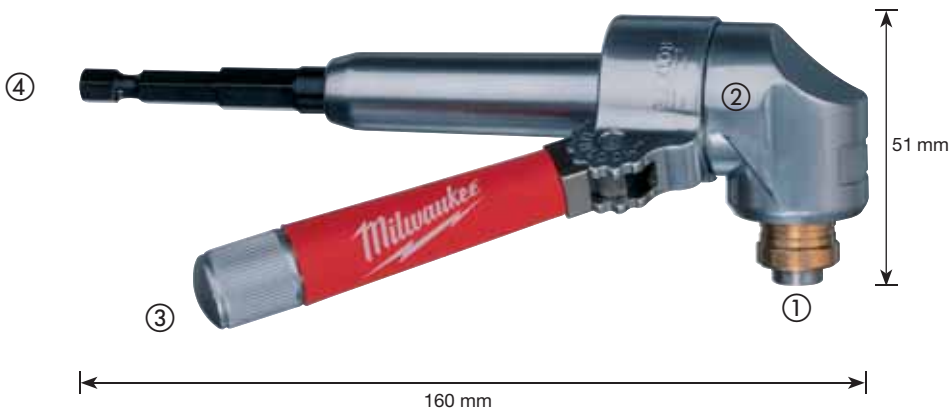

- ① **1/4" Hex bit reception**
 - Magnetic
 - Bit locking mechanism
 - 90° angle to shaft
 - Accepts both standard 25 mm (C 6.3) and ball end reception (E 6.3) screwdriving bits and drill bits
- ② **Metal gears and housing**
 - Precision metal bevel gears for smooth and precise running
 - Excellent power transmission
 - Being only 51 mm high it is perfectly suited for use in confined spaces
- ③ **Softgrip side handle**
 - Rotatable to 360° for left and right hand use
 - With 4 lock positions
- ④ **Two step Hex shaft**
 - Step 1: standard 1/4" (6 mm) Hex shaft for either direct bit reception machines or alternatively into a chuck
 - Step 2: 10 mm Hex shaft for improved grip in larger chucks when carrying out more demanding applications

Industrial quality

- For use with all cordless tools
- Suitable for use in applications up to 40 Nm torque and a maximum of 1750 rpm

Versatility

- The OSD2 is capable of both drilling and screwdriving applications



Description	Quantity	Id. No. 4932	EAN Code 4002395
① OSD2	1	352320	369799
② Counter display (contains 6 x OSD2 - single OSD2 4932352320)	1	352321	369805



System accessories - Screwdrivers

Description	DWE 4000 Q		TKSE 2500 Q 6790	TQSE 1200 Q TQSE 2500 Q 6580/6581	Quantity	Id. No.	UPC/ EAN Code
	DWSE 4000 Q 6743						
① Drywall sleeve assembly	●		●		1	49261036	185245
② Self drill sleeve assembly			●		1	49261082	185375
Magnetic bit holder 1/4" Length 76 mm.	●				1	48323065	128600
Magnetic bit holder 1/4" Length 76 mm. Requires additionally 49261036 sleeve assembly.			●		1	48323070	128655
3 piece Hexagon socket set			●	●	1	49663004	207848
③ Set includes: 6/8/10 mm magnetic sockets.							
M12 BDDX-OA Offset attachment					1	4932430432	4002395380930
④ for screwdriving applications. 12 fixing positions.							
M12 BDDX-RAA Right angle attachment					1	4932430433	4002395380947
⑤ for drilling and screwdriving applications in confined spaces. 90° angle. 12 fixing positions. Direct bit reception.							



System accessories - Sharp-Fire screwdrivers

Description	DWE 4000 Q	SE 2500 LMQ TKSE 2500 Q	Quantity	Id. No.	UPC Code 45242
Square drive bit					
① For use with Sharp-Fire magazine 48051000 - 120 mm long.	●	●	1	48301526	124312
Square drive bit					
① For use with Sharp-Fire magazine 48051005 - 140 mm long.	●	●	1	48301527	124329
Phillips drive bit					
② For use with Sharp-Fire magazine 48051005 - 140 mm long.	●	●	1	48301528	124336
Phillips No 2 drive bit					
② For use with Sharp-Fire magazine 48051000 - 120 mm long.	●	●	1	48301521*	124268









System accessories - Impact wrenches

Description	Quantity	Id. No.	UPC Code 45242
Detent pin - Square type Socket will not slip off unless detent pin is pressed in.	1	49170405	178919
Adaptor:			
① 1/2" square drive to 7/16" and Hex 11 mm. For use with 7/16" selffeed bits and impact auger bits.	1	48660061	155118

Description	M18 CIW	M18 CHIW M28 CHIW	Quantity	Id. No.	UPC Code 45242
② Rubber protective sleeve	✓		1	49162754	320455
		✓	1	49162763	324255



FIXTEC and SDS-plus chuck adaptors

Tool Drive	Reception	Id. No. 4932	EAN Code 4002395	
① FIXTEC	SDS-plus	379877	346561	① 
② FIXTEC	SDS-plus	399152	357628	② 
③ FIXTEC	SDS-plus	352299	369584	③ 
④ FIXTEC	1/2" x 20 UNF	371807	344710	④ 
⑤ FIXTEC	1/2" x 20 UNF	399154	357635	⑤ 
<p>Only suitable for PLH 16 QEX, V28 HX, V18 HX, PLH 26 QEX, PH 30 Power X, KH 26 XE, KH 24 XE, KH 28 Super XE, BH 26 LXE and PH 26 X.</p>				
⑥ SDS-plus	1/2" x 20 UNF	367438	337668	⑥ 
<p>Chuck adaptor with direct bit reception (1/4" Hex) to accept screwdriving bits. Threaded housing enables adaptor to be tightened to the chuck resulting in no wobble.</p>				
⑦ SDS-plus	1/2" x 20 UNF	367166	334438	⑦ 
<p>Chuck adaptor with retaining screw.</p>				

Keyed chucks

Chuck jaws open mm	Reception	Locking device	Safety screw	Rotary drill	Percussion drill	Battery drill	Chuck key	Quantity	Id. No. 4932	EAN Code 4002395
1.0–10	3/8" x 24	●	●	●	●	●	A	1	373412	349760
1.0–10	1/2" x 20	●	●	●	●	●	A	1	269401	302932
1.5–13	1/2" x 20			●	●	●	A	1	218111	300051
1.5–13	1/2" x 20	●	●	●	●	●	A	1	267980	300488
1.0–16	Taper B 16			●			C	1	127010	306169
3.0–16	M 18x2.5	●	●	●	●		C	1	320014	310784
3.0–16	1/2" x 20			●	●		C	1	363753	332953
5.0–20	Taper B 22			●			E	1	117031	305827



Keyed chucks - Machine specific

Chuck jaws open mm	Reception	Machine specific	Chuck key	Safety screw	Quantity	Id. No.	UPC Code 45242
1.0–10	3/8" x 24	HDE 6 RQ	H	●	1	48660817	155705
1.0–10	3/8" x 20	HDE 10 RQ	J	●	1	48662115*	157327
2.0–13	1/2" x 20	HDE 13 RQD	K	●	1	48661355	156542



Keyed chucks with 1/4" Hex reception

Chuck jaws open mm	Reception	Battery drill	Chuck key	Quantity	Id. No. 4932	EAN Code 4002395
0.5–6.5	Hex 1/4"	●	D	1	314867	300112



Chuck keys and accessories

Description	Type	Ref.	Qty.	Id. No. 4932	EAN Code 4002395
① Chuck key	A	S2A	1	221378	302765
	B	S2AT	1	310612	309177
	C	S3T	1	221379	306381
	D	S14	1	304684	300105
	E	S4	1	221380	306398
	G	S2	1	319995	303724
	H		1	48663350	45242157600
	J		1	48663240	45242157501
② Spanner (SW 13) to remove chucks.			1	315788	302611
	Morse taper No. 3 adaptor				
③ for chucks with B 16 or B 22 taper.	MT3 → B16		1	117042	305834
	MT3 → B22			117044	305841
Ejector tool DIN 317 size 3			1	604226	311248

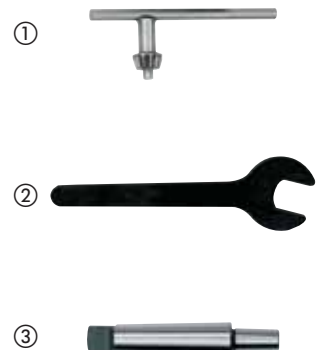

Keyless chucks

Chuck jaws open mm	Reception	Locking device	Safety screw	Rotary drill	Percussion drill	Battery drill	Quantity	Id. No. 4932	EAN Code 4002395
1.0-10	3/8" x 24		●	●		●	1	349457	318155
1.0-10	1/2" x 20	●	●	●	●	●	1	364382	337675
1.5-13	1/2" x 20	●		●	●	●	1	376531	346332
1.5-13	1/2" x 20	●	●	●	●	●	1	376533	346349
1.5-13	1/2" x 20	●		●	●	●	1	364265	334056
1.5-13	1/2" x 20	●	●	●	●	●	1	364267	334070



Keyless chucks for FIXTEC (spindle lock) machines

Chuck jaws open mm	Reception	Locking device	Safety screw	Rotary drill	Percussion drill	Battery drill	Quantity	Id. No. 4932	EAN Code 4002395
1.0-10	3/8" x 24	●	●	●	●	●	1	371018	339365
1.0-10	1/2" x 20	●	●	●	●	●	1	372443	345458
1.5-13	1/2" x 20	●	●	●	●	●	1	371913	345366
1.5-13	3/8" x 24	●	●	●	●	●	1	399492	361137



Industrial keyless chucks for percussion drills

Chuck jaws open mm	Reception	Locking device	Rotary drill	Percussion drill	Battery drill	Quantity	Id. No. 4932	EAN Code 4002395
1.0-13	1/2" x 20	●	●	●	●	1	364266	334063



Industrial keyless chucks for rotary drills

Chuck jaws open mm	Reception	Locking device	Rotary drill	Percussion drill	Battery drill	Quantity	Id. No. 4932	EAN Code 4002395
3.0-16	Taper B 16		●			1	127011	306176



Keyless chucks - specific tool related chucks

Chuck jaws open mm	Reception	Machine specific	Locking device	Rotary drill	Safety screw	Quantity	Id. No.	UPC/ EAN Code
① 1.0-10	1/2" x 20	HDE 10 RQX			●	1	48661520	45242156795
① 1.5-13	1/2" x 20	HDE 13 RQX			●	1	42660755	4002395891436
② 1.5-13	FIXTEC		●	●		1	4932399214	4002395358236
③ 1.0-10	FIXTEC	M12 BDDX		●		1	4932430444	4002395381050



Wet Diamond Drilling Cores

WCHP-SB
8–50 mm



- ① Standard 1/2" G reception
- ② Standard 1 1/4" UNC reception
- ③ Engraving of diameter and type on the core reception for longterm visibility
- ④ Laser welded segments guarantee against break off
- ④ 10 mm segment height for superior lifetime



WCHP-SB
52–152 mm



WCHP
52–350 mm



- Extra thin 2 mm segment for fast and aggressive drilling in reinforced concrete
- Closed ring segment for outstanding performance in tough applications

- Uniquely designed TURBO shaped segments
- Pre-grinded, for best performance right from the first hole
 - One outer and two inner slots enable improved cooling and increased material removal

Material	WCHP-SB WCHP
Aerated/breeze concrete blocks	✓
Artificial stone – hard	✗
Asphalt	✗
Concrete pipes	✓
Concrete reinforced – very abrasive: e.g. – with flint aggregate – with silex (flint) aggregate – soft/green concrete	◆
Concrete reinforced – low abrasive: e.g. – with limestone aggregate	✓
Concrete reinforced – with hard aggregates: e.g. – with granite aggregate – quartz sand aggregate	✓
Fireclay bricks	✗
Lime/sandstone blocks – very hard	✗
Lime/sandstone blocks – medium to hard	◆
Lime/sandstone blocks – soft/abrasive	◆
Granite	✗
Marble	◆
Porphyry	✗
Screed	✓
Stoneware/clay pipes	◆
Slate	◆
Tiles – hard	◆
Tiles – soft	◆

✓ Most suitable. Recommended for these materials.

◆ Limited suitability – recommended for intermittent use. Very good drilling characteristics, but reduced lifetime.

✗ Not suitable. Not recommended for these materials.

Wet diamond drilling cores

Ø mm	Description	Tool suitability		A Core reception	B Working length mm	C Total length mm	Id. No. 4932	EAN Code 4002395
		DD3-152	DCM2-250C DCM2-350C					
8	WCHP-SB 8	✓	◆	½" G	70	135	352072	367269
12	WCHP-SB 12	✓	◆	½" G	200	265	352074	367283
14	WCHP-SB 14	✓	◆	½" G	300	365	352075	367290
16	WCHP-SB 16	✓	◆	½" G	300	365	352077	367313
18	WCHP-SB 18	✓	◆	½" G	300	365	352078	367320
20	WCHP-SB 20	✓	◆	½" G	300	365	352079	367337
22	WCHP-SB 22	✓	◆	½" G	300	365	352080	367344
24	WCHP-SB 24	✓	◆	½" G	300	365	352081	367351
25	WCHP-SB 25	✓	◆	½" G	300	365	352082	367368
28	WCHP-SB 28	✓	◆	½" G	300	365	352083	367375
30	WCHP-SB 30	✓	◆	½" G	300	365	352084	367382
32	WCHP-SB 32	✓	◆	½" G	300	365	352085	367399
35	WCHP-SB 35	✓	◆	½" G	300	365	352086	367405
37	WCHP-SB 37	✓	◆	½" G	300	365	352087	367412
40	WCHP-SB 40	✓	◆	½" G	300	365	352088	367429
42	WCHP-SB 42	✓	◆	½" G	300	365	352089	367436
45	WCHP-SB 45	✓	◆	½" G	300	365	352090	367443
50	WCHP-SB 50	✓	◆	½" G	300	365	352092	367467
52	WCHP 52		✓	1 ¼" UNC	420	500	399707	363582
	WCHP-SB 52	✓		1 ¼" UNC	420	500	352734	373925
62	WCHP 62		✓	1 ¼" UNC	420	500	399708	363599
	WCHP-SB 62	✓		1 ¼" UNC	420	500	352735	373932
72	WCHP 72		✓	1 ¼" UNC	420	500	399709	363605
82	WCHP 82		✓	1 ¼" UNC	420	500	399710	363612
	WCHP-SB 82	✓		1 ¼" UNC	420	500	352736	373949
92	WCHP 92		✓	1 ¼" UNC	420	500	399711	363629
	WCHP-SB 92	✓		1 ¼" UNC	420	500	352737	373956
102	WCHP 102		✓	1 ¼" UNC	420	500	399712	363636
	WCHP-SB 102	✓		1 ¼" UNC	420	500	352738	373963
112	WCHP 112		✓	1 ¼" UNC	420	500	399713	363643
	WCHP-SB 112	✓		1 ¼" UNC	420	500	352739	373970
122	WCHP 122		✓	1 ¼" UNC	420	500	399714	363650
	WCHP-SB 122	✓		1 ¼" UNC	420	500	352740	373987
132	WCHP 132		✓	1 ¼" UNC	420	500	399715	363667
	WCHP-SB 132	✓		1 ¼" UNC	420	500	352741	373994
152	WCHP 152		✓	1 ¼" UNC	420	500	399716	363674
	WCHP-SB 152	✓		1 ¼" UNC	420	500	352742	374007
162	WCHP 162		✓	1 ¼" UNC	420	500	399717	363681
172	WCHP 172		✓	1 ¼" UNC	420	500	352052	367092
182	WCHP 182		✓	1 ¼" UNC	420	500	399718	363698
202	WCHP 202		✓	1 ¼" UNC	420	500	399719	363704
225	WCHP 225		✓	1 ¼" UNC	420	500	399720	363711
250	WCHP 250		✓	1 ¼" UNC	420	500	399721	363728
300	WCHP 300		✓	1 ¼" UNC	420	500	399722	363735
350	WCHP 350		✓	1 ¼" UNC	420	500	399723	363742

✓ Most suitable ◆ Limited suitability

WCHP-SB
Ø 8–50 mm

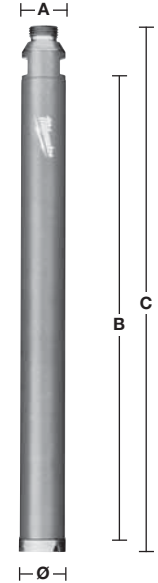

WCHP-SB
Ø 52–152 mm

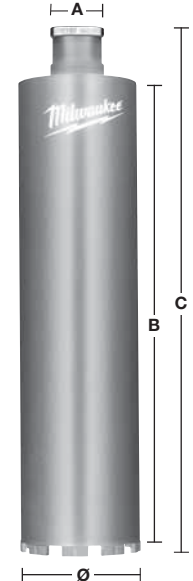

WCHP
Ø 52–350 mm

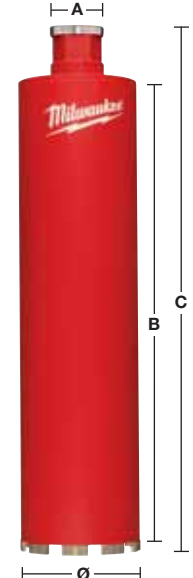

System accessories - Wet diamond drilling

Description	DD3-152	DCM2-250C / 350C	Id. No. 4932	EAN Code 4002395
Fixing kit For exclusive use in concrete! Including stud bolt, setting tool, wing nut, washer and 5 pcs M12 drop anchor (Ø 16 mm drill bit is required to set the drop anchor).	●	●	399731	363827
Spanners 1 3/8" open open ended spanner. For holding the motor output spindle while removing a core bit. 32 mm ended spanner. For holding the motor output spindle while removing a core bit. 41 mm open ended spanner. For removing the core bit from the motor spindle.	●	●	49964705 4931428009 4931428010	45242222766 844791 844807
FIXTEC release Suitable for all diamond motors with 1 1/4" spindle reception. Prevents the core bit from locking itself too tight onto the machine spindle. The core bits can then be released and removed with minimum effort.	●	●	352053	367108
Adaptor: 1 1/4" to 1/2" 1 1/4" female to 1/2" female adaptor. To enable the connection of <50 mm diamond core drill bits on a 1 1/4" machine spindle thread.	●	●	352627	372850
Extension rods ③ 1 1/4" female/male extension rod, length 300 mm. 1 1/4" female/male extension rod, length 500 mm.	●	●	399724 399725	363759 363766
Telescopic extension Extension pole used to fix drill rig to the ground instead of anchor bolts. Maximum load of 500 kg and adjustable extension height from 1.8–2.9 m.	●	●	399732	363834
Vacuum pump VP 6 For fastening of the diamond drill rig on smooth and even surfaces. ⑤ Standard equipment: 5 m hose with DW7 connection. Suction capacity: 850 mbar. Max. vacuum pressure: 6 m³/h/100l/min. Rated voltage: 220–240 V.	●	●	352094	367474
Vacuum plate ⑥ Replacement rubber seal 4931428665.	●		352676	373345
WT 10 watertank ⑦ 10 liters capacity, steel water tank with inside and outside polyester coating. Reliable brass pump with a max. pressure of 6 bar. 2.5 m hose with quick connection system fits direct to Milwaukee® diamond drills.	●	●	399726	363773
Water collection ring For use with drill rig DR 152 T. For use with max. Ø 152 mm core bits. Replacement rubber ring for DR 152 T. ⑧ For use with drill rig DR 250 TV. For use with max. Ø 180 mm core bits. ⑨ Replacement rubber ring for DR 250 TV. For use with drill rig DR 350 T. For use with max. Ø 300 mm core bits. Replacement rubber ring for DR 350 T.			352677 352678 399727 399729 399728 399730	373352 373369 363780 363803 363797 363810
Spacer block T= 50 mm ⑩ Needs to be mounted between drill rig and motor for cores >250 mm and max. 350 mm. Included in drill rig DR 350 T.		●	399736	363872
Quick connection motor mounting plate Included in both drill rigs DR 250 TV and DR 350 T.		●	399733	363841

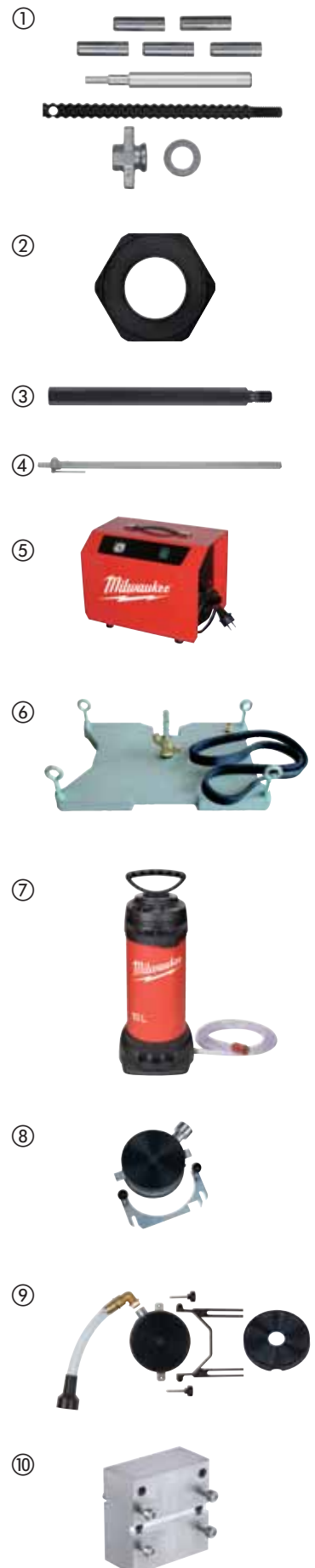

FIXTEC Diamond Core System

The patented Milwaukee® range of FIXTEC diamond core adaptors allows changing diamond cores in a matter of seconds without the use of extra tools.

The most common complaint with existing systems is that the diamond core locks itself tight onto the machine making it increasingly difficult to later remove the core, even with the aid of spanners and wrenches. However with the new FIXTEC adaptor solution from Milwaukee® this is a problem of the past, the cores can be unscrewed, removed and exchanged quite simply by hand – there is no need for spanners or wrenches.

The revolutionary FIXTEC adaptors are available with or without dust absorption and with different tool receptions making them compatible to other manufacturers tools.

The Past



The Future



FIXTEC solution

FIXTEC solution with dust extraction

FIXTEC Clean Line Rotor (CLR)

Fits to diamond cores with 1 1/4" UNC thread. The added advantage of dust absorption allows drilling speed to be increased and extends the lifetime of diamond cores.

Description	A Tool reception	B Core reception	Id. No. 4932	EAN Code 4002395
FIXTEC Clean Line Rotor (CLR)	M 18 x 2.5	1 1/4" UNC	352172	368242



FIXTEC solution without dust extraction

FIXTEC adaptor

Fits to diamond cores with M16 thread.

As centering drill bit a standard SDS-plus drill bit can be used.

Description	A Tool reception	B Core reception	Id. No. 4932	EAN Code 4002395
FIXTEC adaptors	M 18 x 2.5	M16	399174	357819
	Hex 11 mm	M16	399220	358342



Dry diamond cores with dust extraction - DCHXL

- 10 mm high segments for longer life.
- Laser welded segments for extra durability.
- ▲ Use with the machine set to rotary only, not suitable for hammer action.
- ▲ During pre-drilling the centering unit (centering stars, guide rod and SDS-plus pilot drill bit) must be used.



Material	DCHXL	Material	DCHXL
Aerated/breeze concrete blocks	◆	Granite	✘
Artificial stone – hard	✘	Lime/sandstone – hard	✓
Brick – very hard, engineering brick	✓	Lime/sandstone – soft/abrasive	◆
Brick – medium	✓	Marble	✘
Brick – soft	◆	Tiles	✘
Concrete	✘		

✓ Most suitable. Recommended for these materials.
✘ Not suitable. Not recommended for these materials.

◆ Limited suitability – recommended for intermittent use.
Very good in drilling characteristics, but reduced lifetime.

Description	Ø mm	A Core reception	B Working length mm	C Total length mm	Id. No. 4932	EAN Code 4002395
DCHXL 38 ¹⁾	38	1 1/4" UNC	420	490	399753	364060
DCHXL 52	52	1 1/4" UNC	420	490	399163	357703
DCHXL 68	68	1 1/4" UNC	420	490	399164	357710
DCHXL 82	82	1 1/4" UNC	420	490	399165	357727
DCHXL 102	102	1 1/4" UNC	420	490	399166	357734
DCHXL 107	107	1 1/4" UNC	420	490	399754	364077
① DCHXL 112	112	1 1/4" UNC	420	490	399167	357741
DCHXL 117	117	1 1/4" UNC	420	490	399755	364084
DCHXL 122	122	1 1/4" UNC	420	490	399168	357758
DCHXL 127	127	1 1/4" UNC	420	490	399169	357765
DCHXL 132	132	1 1/4" UNC	420	490	399170	357772
DCHXL 152	152	1 1/4" UNC	420	490	399171	357789
DCHXL 162	162	1 1/4" UNC	420	490	399172	357796

¹⁾ During pre-drilling no centering star required.

Description	A Tool reception	B Core reception	Id. No. 4932	EAN Code 4002395
② FIXTEC Clean Line Rotor (CLR)	M 18x2.5	1 1/4" UNC	352172	368242

Description	Id. No. 4932	EAN Code 4002395
③ Guide rod for DD2-160. Supplied with locking screw (4931622432). Requires allen key (4931616044) and SDS-plus pilot drill bit (8 x 160 mm, 4932307071).	399173	357802
④ Guide rod for DD3-152. Requires SDS-plus pilot drill bit (8 x 110 mm, 4932307070).	352679	373376

Centering star (2 pieces pack) (For use only with guide rod 399173)

Ø mm	Id. No. 4931	EAN Code 4002395	Ø mm	Id. No. 4931	EAN Code 4002395
52	393176	358380	117	403508	364107
68	393177	358397	122	393181	780709
82	393178	358403	127	393182	780716
⑤ 102	393179	358410	⑤ 132	393183	358458
107	403507	364091	152	393184	358465
112	393180	358427	162	393185	358472

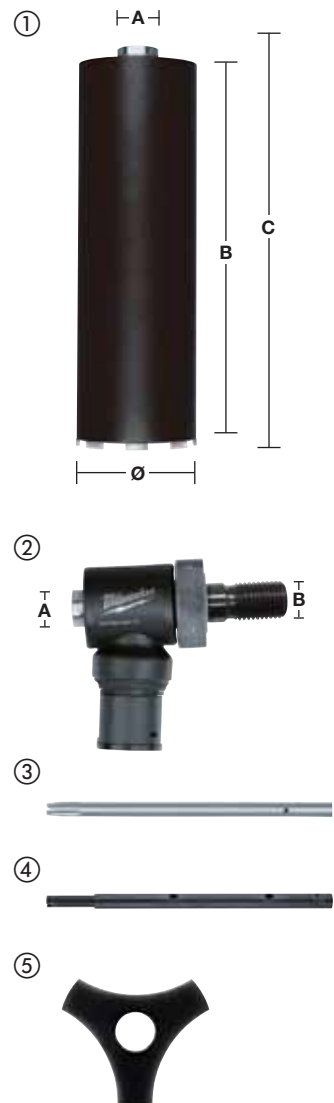

Dry diamond cores for electrical sockets with dust extraction - DCHX

- 10 mm high segments for longer life.
 - Laser welded segments for extra durability.
 - Suitable for installation of electrical sockets and junction boxes.
- ▲ Use with the machine set to rotary only, not suitable for hammer action.

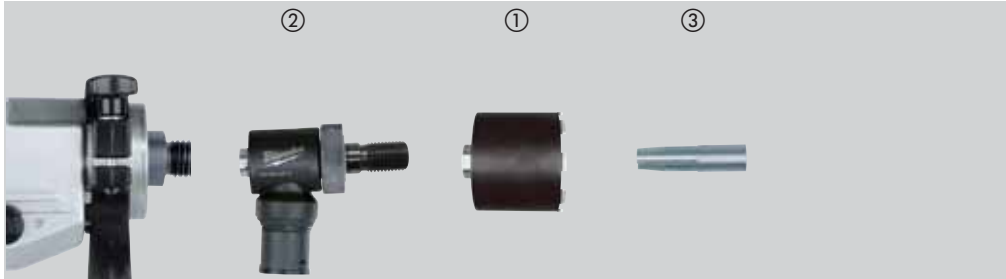

Material	DCHX	Material	DCHX
Aerated/breeze concrete blocks	◆	Granite	✘
Artificial stone – hard	✘	Lime/sandstone – hard	✓
Brick – very hard, engineering brick	✓	Lime/sandstone – soft/abrasive	◆
Brick – medium	✓	Marble	✘
Brick – soft	◆	Tiles	✘
Concrete	✘		

- ✓ Most suitable. Recommended for these materials.
- ◆ Limited suitability – recommended for intermittent use. Very good in drilling characteristics, but reduced lifetime.
- ✘ Not suitable. Not recommended for these materials.

Description	Ø mm	A Core reception	B Working length mm	C Total length mm	Id. No. 4932	EAN Code 4002395
① DCHX 68	68	1¼" UNC	60	130	399217	358311
① DCHX 82	82	1¼" UNC	60	130	399218	358328

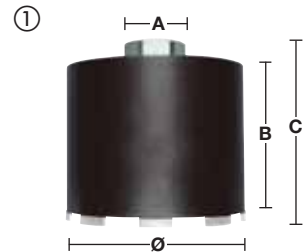

Description	A Tool reception	B Core reception	Id. No. 4932	EAN Code 4002395
② FIXTEC Clean Line Rotor (CLR)	M 18 x 2.5	1¼" UNC	352172	368242

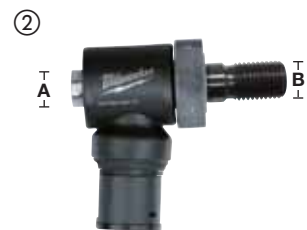

Description	Id. No. 4932	EAN Code 4002395
Guide rod for DD2-160. Supplied with locking screw (4931622432). Requires allen key (4931616044) and	399221	358359
③ SDS-plus pilot drill bit (8 x 110 mm, 4932307070).		
Guide rod for DD3-152. Requires SDS-plus pilot drill bit (8 x 110 mm, 4932307070).	352680	373383



Dry diamond drilling for electrical sockets without dust extraction - DCU/DCH

- 7 mm high segments.
- Laser welded segments for extra durability.
- Suitable for installation of electrical sockets and junction boxes.
- ▲ Use with the machine set to rotary only, not suitable for hammer action.

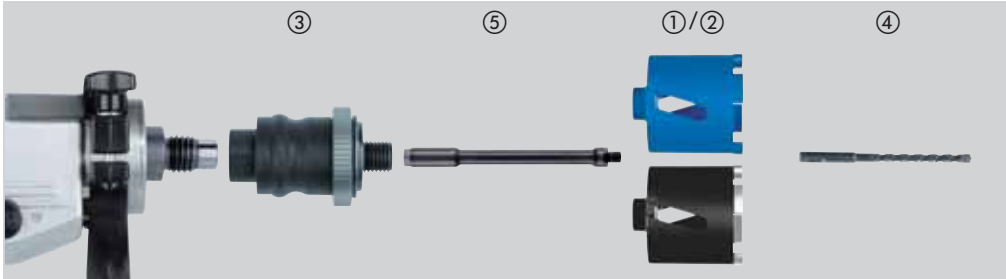

Material	DCU	DCH	Material	DCU	DCH
Aerated/breeze concrete blocks	◆	◆	Granite	✗	✗
Artificial stone – hard	✗	✗	Lime/sandstone – hard	◆	✓
Brick – very hard, engineering brick	◆	✓	Lime/sandstone – soft/abrasive	✓	◆
Brick – medium	✓	✓	Marble	✗	✗
Brick – soft	✓	◆	Tiles	✗	✗
Concrete	✗	✗			

- ✓ Most suitable. Recommended for these materials.
- ◆ Limited suitability – recommended for intermittent use. Very good in drilling characteristics, but reduced lifetime.
- ✗ Not suitable. Not recommended for these materials.

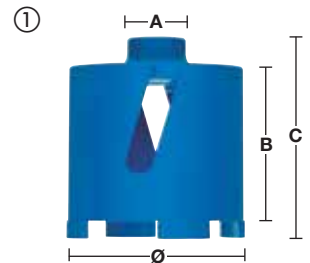

Description	Ø mm	A Core reception	B Working length mm	C Total length mm	Id. No. 4932	EAN Code 4002395
① DCU 68	68	M 16	60	90	371978	346035
① DCU 82	82	M 16	60	90	371979	346042
② DCH 68	68	M 16	60	90	399579	362080
② DCH 82	82	M 16	60	90	399580	362097

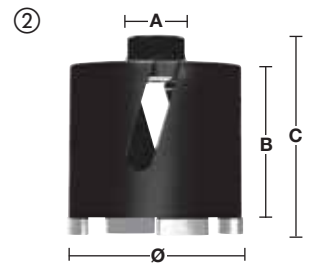

Description	A Tool reception	B Core reception	Id. No. 4932	EAN Code 4002395
FIXTEC adaptors	M 18x2.5	M 16	399174	357819
③ Tool changing in seconds. No extra tool required.	Hex 11	M 16	399220	358342
④ Requires SDS-plus pilot drill bit (Ø 8 x 160 mm).			307071	308873



Description	A Adaptor reception	B Core reception	C Total length mm	Id. No. 4932	EAN Code 4002395
Extension					
⑤ between FIXTEC adaptor and diamond core.	M 16	M 16	300	369736	346028

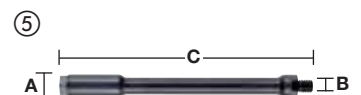

Dry diamond drilling without dust extraction - DCH 150

- 10 mm high segments.
- Laser welded segments for extra durability.
- ▲ Use with the machine set to rotary only, not suitable for hammer action.

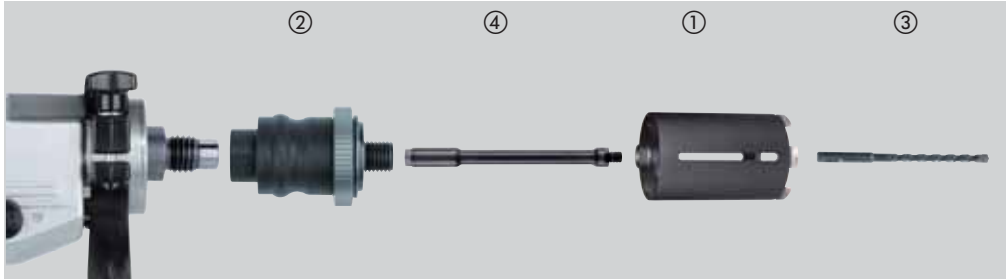

Material	DCH	Material	DCH
Aerated/breeze concrete blocks	◆	Granite	✘
Artificial stone – hard	✘	Lime/sandstone – hard	✓
Brick – very hard, engineering brick	✓	Lime/sandstone – soft/abrasive	◆
Brick – medium	✓	Marble	✘
Brick – soft	◆	Tiles	✘
Concrete	✘		

- ✓ Most suitable. Recommended for these materials.
- ◆ Limited suitability – recommended for intermittent use. Very good in drilling characteristics, but reduced lifetime.
- ✘ Not suitable. Not recommended for these materials.

Description	Ø mm	A Core reception	B Working length mm	C Total length mm	Id. No. 4932	EAN Code 4002395
DCH 150-52	52	M16	150	180	352628	372867
DCH 150-62	62	M16	150	180	352629	372874
① DCH 150-68	68	M16	150	180	352630	372881
DCH 150-82	82	M16	150	180	352631	372898
DCH 150-102	102	M16	150	180	352632	372904
DCH 150-127	127	M16	150	180	352633	372911

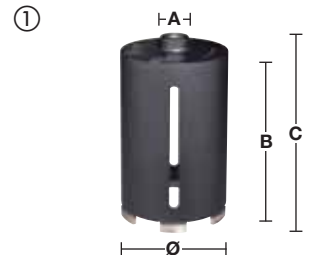

Description	A Tool reception	B Core reception	Id. No. 4932	EAN Code 4002395
FIXTEC adaptors	M 18x2.5	M16	399174	357819
② Tool changing in seconds. No extra tool required.	Hex 11	M16	399220	358342
③ Requires SDS-plus pilot drill bit (Ø 8 x 260 mm).			353821	320141



Description	A Adaptor reception	B Core reception	C Total length mm	Id. No. 4932	EAN Code 4002395
Extension					
④ between FIXTEC adaptor and diamond core.	M16	M16	300	369736	346028





Nothing but **HEAVY DUTY.**[™]

SPEED

MILWAUKEE® SPEEDCROSS DIAMOND BLADES ARE ENGINEERED FOR ALL CONSTRUCTION SITE PROFESSIONALS WHO DEMAND ONLY THE BEST IN PERFORMANCE WHEN WORKING IN THE TOUGHEST ENVIRONMENTS.



Segments

10 mm segment height to ensure long lifetime. High diamond concentration with special aggressive geometry gives a high cutting performance. Laser welded segments for 100% user safety.

Precision engineered blade body

Pre-tensioned and hardened blade body for perfect concentration and maximum resistance to heat build up.

Cool cutting slots

The slots and holes improve the airflow keeping the cutting temperature of the segments to a minimum. This safeguards the segments from heat damage and allows the user to cut more and quicker.

Noise reduction qualities

Perfect balance and concentration suppress cutting noise.

Low vibration

The tensioned blade body eliminates wobble and minimises vibration.

Laser marked

All technical/safety information plus the direction of rotation arrow is laser marked for the complete life of the blade. Even when used in abrasive materials the information will not wear off.

**DIAMOND PREMIUM BLADES
MAXIMUM SPEED!**

Speedcross Blades

CROSS

**MAXIMUM SPEED,
LONG LIFE,
LOW VIBRATION!**

- Universal blades for a variety of materials
- Classed into two categories for maximum lifetime
- 10 mm segments height to ensure long lifetime
- Laser welded segments, so 100% user friendly
- Low vibration



**HUDD
HARD UNIVERSAL**



**AUDD
ABRASIVE UNIVERSAL**

Application areas

The Speedcross blades are both universal in application but their best performance is achieved at different ends of the spectrum. The HUDD is predominantly a blade for very hard to medium hard general building materials, the harder the material the better the performance. Alternatively the AUDD is most suitable for hard materials to soft/abrasive materials, its best performance is achieved when used in standard hardness concrete and general building materials.

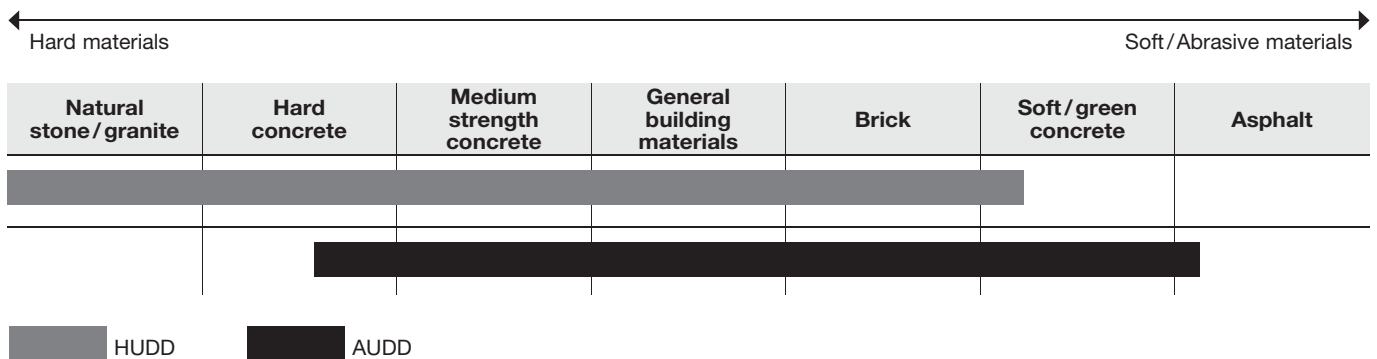

SPEEDCROSS HUDD

Type	Blade Ø mm	Bore Ø mm	Segment height mm	Cutting width mm	Qty.	Id. No. 4932	EAN Code 4002395
HUDD 115	115	22.23	10	2.6	1	399819	364749
HUDD 125	125	22.23	10	2.6	1	399820	364756
HUDD 150	150	22.23	10	2.6	1	399821	364763
HUDD 230	230	22.23	10	2.6	1	399822	364770



SPEEDCROSS AUDD

Type	Blade Ø mm	Bore Ø mm	Segment height mm	Cutting width mm	Qty.	Id. No. 4932	EAN Code 4002395
AUDD 115	115	22.23	10	2.6	1	399823	364787
AUDD 125	125	22.23	10	2.6	1	399824	364794
AUDD 150	150	22.23	10	2.6	1	399825	364800
AUDD 230	230	22.23	10	2.6	1	399826	364817



Diamond blades

DU

A general purpose blade offering good performance in speed and lifetime in a wide variety of construction materials.



Type	Blade Ø mm	Bore Ø mm	Segment height mm	Cutting width mm	Qty.	Id. No. 4932	EAN Code 4002395
DU 115	115	22.23	10	2.2	1	399521	361687
DU 125	125	22.23	10	2.3	1	399522	361694
DU 180	180	22.23	10	2.4	1	399523	361700
DU 230	230	22.23	10	2.6	1	399524	361717

DUT

A general purpose turbo rimmed blade for cutting a wide variety of general building materials. The turbo rim ensures clean chip free cuts.



Type	Blade Ø mm	Bore Ø mm	Segment height mm	Cutting width mm	Qty.	Id. No. 4932	EAN Code 4002395
DUT 115	115	22.23	10	2.2	1	399526	361731
DUT 125	125	22.23	10	2.3	1	399527	361748
DUT 180	180	22.23	10	2.4	1	399528	361755
DUT 230	230	22.23	10	2.6	1	399529	361762

DUH

A trade laser welded quality blade with exceptional performance in hard materials such as hard concrete, block paviers and masonry products.



Type	Blade Ø mm	Bore Ø mm	Segment height mm	Cutting width mm	Qty.	Id. No. 4932	EAN Code 4002395
DUH 115	115	22.23	10	2.2	1	399539	361861
DUH 125	125	22.23	10	2.3	1	399540	361878
DUH 180	180	22.23	10	2.4	1	399541	361885
DUH 230	230	22.23	10	2.6	1	399542	361892

DHTS

A trade quality turbo rimmed blade with extra thin body (DHTS 115=1.7 mm, DHTS 125/DHTS 230=1.8 mm) for very fast, precise and chip free cuts in thin materials such as granite, marble slabs and tiles (type: porcelain, gres, ceramic). Due to the high quality of this blade it is also suitable for cutting most building materials.



Type	Blade Ø mm	Bore Ø mm	Segment height mm	Cutting width mm	Qty.	Id. No. 4932	EAN Code 4002395
DHTS 115	115	22.23	10	1.2	1	399145	357550
DHTS 125	125	22.23	10	1.2	1	399146	357567
DHTS 230	230	22.23	10	1.9	1	399550	361977

Diamond blades

DHTi

Specifically designed turbo rimmed blade for clean cut edges in ceramic tiles and thin natural stone tiles/slabs.



Type	Blade Ø mm	Bore Ø mm	Segment height mm	Cutting width mm	Qty.	Id. No. 4932	EAN Code 4002395
DHTi 115	115	22.23	8	2.0	1	399552	361991
DHTi 125	125	22.23	8	2.1	1	399553	362004
DHTi 230	230	22.23	8	2.6	1	399555	362028

DSU

A trade quality universal blade, specially designed for hard and abrasive materials. Laser welded segments provide long lifetime and excellent cutting performance. Recommended for use with wall chasers.



Type	Blade Ø mm	Bore Ø mm	Segment height mm	Cutting width mm	Qty.	Id. No. 4932	EAN Code 4002395
DSU 125	125	22.23	10	2.4	1	373147	346455
DSU 150	150	22.23	10	2.4	1	373148	346462

Combi-segment diamond cup wheels

All-rounder in applications:

For quick **grinding** down of thick concrete layers.

For **levelling** of concrete, granite and natural stone surfaces.

For **edge grinding** applications e.g. grinding off high edges of concrete, granite, natural stone tiles.

For **roughening** prior to covering with a new layer of coating.

High quality diamonds and special soft bonding for low wear, especially in hard materials.

Large openings for better dust removal and segment cooling.



Application material

Artificial stone	✓
Aerated/breeze concrete blocks	✓
Asphalt	✗
Basalt	✓
Brick – hard/engineering brick	✓
Brick – soft/medium to very abrasive	✓
Concrete – hard/old/low abrasiveness	✓
Concrete – soft/fresh/medium to very abrasive	◆
Concrete tiles/slabs/pipes	✓
Granite/Gneiss	✓
Lime/Sandstone blocks – low abrasiveness	✓
Lime/Sandstone blocks – medium to very abrasive	◆
Marble tiles/slabs	✓
Mortar, plaster	✓
Natural slate	◆
Plaster/Plaster board	◆
Porphyry	◆
Screed concrete	◆
Thermoplastic protective paint/glue	✗
Tile adhesive	✓

✓ Most suitable ◆ Suitable ✗ Not suitable

Ø mm	Bore Ø mm	Total height mm	Id. No. 4932	EAN Code 4002395
100	22.23	22	430080	377411
125	22.23	22	430081	377428

Diamond blades: Which diamond cutting blade for which material?

Material	Type	Speedcross Premium		Professional					
		HUDD	AUDD	DU	DUT	DUH	DHTS	DHTi	DSU
Abrasive refractory materials		◆	✓						
Aerated concrete/breeze blocks		◆	✓	✓	✓	✓			◆
Artificial stone		✓			✓	✓			✓
Artificial stone – hard		✓				✓	✓	◆	✓
Asphalt			◆						
Basalt		✓	✓		✓	✓			✓
Brick – very hard, engineering brick		✓			◆	✓			✓
Brick – medium to hard		✓		◆	◆	✓			✓
Brick – medium to soft		✓	✓	◆	◆	◆			✓
Concrete – hard		✓	◆			✓			✓
Concrete – medium		✓	✓	✓	✓	✓			✓
Concrete – soft/green		◆	✓						◆
Concrete with flint aggregate		◆	✓						
Concrete with flint and rebar		◆	✓						
Concrete kerbstones		✓	✓			✓			✓
Concrete lintels		✓	◆			✓			✓
Concrete block paviors		✓	✓	◆	◆	✓			✓
Concrete tiles		✓	✓	✓	✓	✓	◆		✓
Concrete reinforced with rebar		✓	◆	◆	◆	✓			✓
Concrete slabs		✓	◆			✓			✓
Concrete slabs with aggregate		✓	✓		◆	✓			✓
Fireclay		✓	✓			✓			✓
General building materials		✓	✓	✓	✓	✓			✓
Gneiss		✓				◆			◆
Granite		✓			✓	✓			✓
Granite tiles/slabs		◆			✓	◆	✓		◆
Lime/sandstone blocks – hard		✓	✓			✓			✓
Lime/sandstone blocks – medium		✓	✓	◆	◆	✓			
Lime/sandstone – soft/abrasive		◆	✓	◆	◆	◆			◆
Marble tiles/slabs		◆			✓	◆	✓	◆	✓
Metal channel/profiles							◆		
Poroton		✓	✓	✓	✓	✓			✓
Porphyry		✓			◆	✓	✓		✓
Roof tiles – clay		✓	◆	◆	✓	◆	✓		✓
Roof tiles – concrete		✓	✓		✓	◆	✓		✓
Screed		◆	✓	◆	◆	◆			◆
Slate		✓	◆	◆	✓	✓	✓		◆
Stoneware/clay tiles		✓	✓		✓	✓			✓
Tiles – ceramic					◆		✓	✓	
Tiles – porcelain and gres type					◆		✓	◆	
Tiles – terrazo type		✓	◆		✓	✓	✓		✓

✓ Most suitable. Recommended for these materials. Very long service life and very good cutting characteristics.

◆ Suitable. Recommended for intermittent use in these materials. Good service life and cutting characteristics.

System accessories - Wall chasers

AUDD blade is a perfect solution for 80% of wall chaser applications.

- 40% higher speed of cut
- 30% less loading on the machine

Application areas

SPEEDCROSS

Material	① HUDD	② AUDD	③ DSU
Abrasive refractory materials	◆	✓	
Aerated concrete blocks	◆	✓	◆
Brick - medium to soft	✓	✓	✓
Concrete - medium/hard	✓	✓	✓
Concrete reinforced	✓	◆	✓
Concrete with flint and rebar	◆	✓	
Fireclay	✓	✓	✓
General building materials	✓	✓	✓
Granite	✓		✓
Lime/sandstone - soft/abrasive	◆	✓	◆
Sandstone		✓	
Screed	◆	✓	◆

✓ Maximum performance ◆ Limited suitability - recommended for intermittent use



Description	DME 30 MFE 1305 WCE 30 MFE 1500	DME 45 MF 1900 WCS 45	DME 65 WCE 65	Quantity	Id. No. 4932	EAN Code 4002395
Transport case Metal	●	●		1	383357	357390
④ Pin spanner	●	●	●	1	367712	338467
⑤ T-handle key	●	●	●	1	4931362928	661879
Dust protection grille against entry of ground particles.	●	●		1	329397	303892
⑥ Dust protection grille against entry of ground particles. Also suitable for MFE 1305.			●	2	326525	303311
Extension hose Length: 4 m, Ø 35 mm Requires adaptor (362778).	●	●	●	1	330552	312719
Adaptor with bayonet fitting for direct connection of hose to machine.	●	●	●	1	362778	334285
⑦ Side handle	●	●		1	409546	370870
Flange nut				1	334667	304448
Clamping flange - suitable for DME 1300/MFE 1305.				1	334706	304455
Spacer set - 6 rings - suitable for MFE 1305 only.					4931334675	762804
Spacer set - suitable for DME 30/45/65, WCE 30, WCE 65.					4931362797	764068

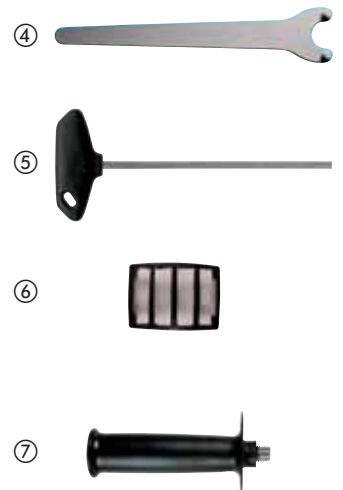

Cutting and grinding discs

Milwaukee® Type - how to find the right disc

SC 41/115

Material	Application	Design	Diameter	
S = Steel C = Stone	C = Cutting G = Grinding CS = Cutting Slim L = Flap LC = Flap Ceramic CT = Cutting Thin	 flat 41 depressed 42 depressed 27 flap 50	mm	inches
			100	4
			115	4½
			125	5
			150	6
			180	7
			230	9
			355	14



Thin metal cutting discs

Applications: iron and sulphur free top line thin cut-off wheels for all steels. Best suitable for stainless and acid-resistant steel, hardox, heat-resistant cast steel, spring steel, mild and tool steel.

Characteristics: +30 % more life, 50 % less cutting time, 50 % less dust. Lower material loss.

Type	Disc Ø mm	Thickness mm	Bore Ø mm	Qty.	Id. No. 4932	EAN Code 4002395
41 SCT 41/115*	115	1.5	22.2	1	430445	381067
SCS 41/115	115	1	22.2	50	371902	345281
① Counter display (200x SCS 41/115 discs)				200	371895	345373
SCS 41/125	125	1	22.2	50	371903	345298
① Counter display (200x SCS 41/125 discs)				200	371900	345380
SCS 41/180	180	1.5	22.2	25	371904	345304
SCS 41/230	230	1.9	22.2	25	371905	345311

①



*Orders are only possible in master carton / contains 50 x 4932430445. Minimum order quantity is 50 x 4932430445 (= master carton). Order quantities greater than 50 pcs are to be ordered in multiples of 50 pcs (i.e. 100, 150, 200...).

Metal cutting discs

Applications: great performance in cutting mild steel with medium strength, plain alloy tool steel, concrete reinforcing iron and steel rebar.

Characteristics: efficient cutting properties in combination with high performance.

Type	Disc Ø mm	Thickness mm	Bore Ø mm	Qty.	Id. No. 4932	EAN Code 4002395
41 SC 41/115	115	3	22.2	25	490063	326174
SC 41/125	125	3	22.2	25	490064	326181
SC 41/180	180	3	22.2	25	490065	326198
SC 41/230	230	3	22.2	25	490066	326204
42 SC 42/115	115	3	22.2	25	490068	326228
SC 42/125	125	3	22.2	25	490069	326235
SC 42/180	180	3	22.2	25	490070	326242
SC 42/230	230	3	22.2	25	490071	326259

Metal cutting discs for chop saws

Applications: for structural steels, tool steel, cast iron, hard high-grade steels and concrete reinforcing steel bars (rebar).

Characteristics: soft cutting wheel for chop saws.

Type	Disc Ø mm	Thickness mm	Bore Ø mm	Qty.	Id. No. 4932	EAN Code 4002395
41 SC 41/355	355	2.5	25.4	10	373734	352548
SC 41/355*	355	2.5	25.4	1	373746	352739

*Minimum order quantity = 10 pcs. Orders >10 pcs must be ordered in multiples of 10 (i.e. 10, 20, 30, 40).

Metal grinding discs

Applications: sound performance in mild steel and non-alloy tool steel.

Characteristics: provides good lifetime and efficient grinding characteristics.

Type	Disc Ø mm	Thickness mm	Bore Ø mm	Qty.	Id. No. 4932	EAN Code 4002395
27 SG 27/115	115	6	22.2	25	490098	325917
SG 27/125	125	6	22.2	25	490099	325924
SG 27/180	180	6	22.2	10	490100	325931
SG 27/230	230	6	22.2	10	490102	325955

Flap discs

Maximum productivity with CERA TURBO™
50% faster material removal
2x longer lifetime

- **Ceramic hybrid disc:** grinds steel, stainless steel, bronze, titanium, aluminium.
- **Ceramic grain:** grinds and finishes in one step! Material removal like grit 40, finishing result like grit 60!
- **Self trimming backing pad:** allows grinding to the last grain!
- **Natural fibre backing pad:** low vibration & noise, no harmful dust.
- **Highly flexible:** perfectly adjusts to working piece.
- **Low heat development:** no metal discolouration, especially on stainless steel.
- **Made in Germany**
- ▲ **Ideal grinding speed:** Ø 115 mm: 7.000–8.000 rpm
 Ø 125 mm: 6.000–7.000 rpm

Applications: ferrous metals, non-ferrous metals (aluminium, titan, etc.), stainless steel V2A (1.4301) / V4A (1.4401)

Type	Disc Ø mm	Grit	Bore Ø mm	Qty.	Backing plate material	Id. No. 4932	EAN Code 4002395
50	SLC50/115	115	Multigrain 40/60	22.2	1	Natural Fibre	430407 380688
	SLC50/125	125	Multigrain 40/60	22.2	1	Natural Fibre	430408 380695

Orders are only possible in master cartons (contains 10x 4932430407).
 Minimum order quantity is 10x 4932430407 (= 1 master carton).
 Order quantities greater than 10 pcs are to be ordered in multiples of 10 pcs (i.e. 20, 30, 40, 50...).

- **High quality zirconium grain:** longer lifetime on ferrous metals and stainless steel.
- **Self trimming backing pad:** allows grinding to the last grain!
- **Natural fibre backing pad:** low vibration & noise, no harmful dust.
- **Highly flexible:** perfectly adjusts to working piece.
- **Low heat development:** no metal discolouration, especially on stainless steel.
- **Made in Germany**
- ▲ **Ideal grinding speed:** Ø 115 mm: 7.000–8.000 rpm
 Ø 125 mm: 6.000–7.000 rpm

Applications: ferrous metals, stainless steel V2A (1.4301) / V4A (1.4401)

Type	Disc Ø mm	Grit	Bore Ø mm	Qty.	Backing plate material	Id. No. 4932	EAN Code 4002395
50	SL50/115	115	80	22.2	1	Natural Fibre	430412 380732
	SL50/115	115	120	22.2	1	Natural Fibre	430413 380749
	SL50/125	125	80	22.2	1	Natural Fibre	430414 380756
	SL50/125	125	120	22.2	1	Natural Fibre	430415 380763

Orders are only possible in master cartons (contains 10x 4932430412).
 Minimum order quantity is 10 x 4932430412 (= 1 master carton).
 Order quantities greater than 10 pcs are to be ordered in multiples of 10 pcs (i.e. 20, 30, 40, 50...).

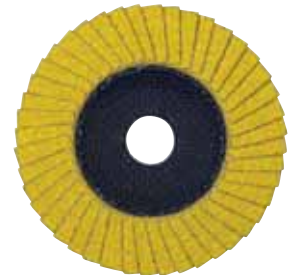

FIXTEC nut

- FIXTEC: disc changing in seconds, no extra tools required.
- 12 seconds from removing the worn disc to fixing a new disc.
- Only 8 mm thin, enabling more surface of disc on the material.
- Compatible to all manufacturers angle grinders up to Ø 150 mm with standard M14 spindle thread.
- With integrated keyholes, for removal of the nut with a standard pin spanner in the event of the nut becoming too tight.



Description	Pack quantity	Order quantity	Id. No.	EAN Code
FIXTEC nut Counter display	12	12	352473	371327



WS-T1

- Cutting stand suitable for most angle grinders up to 230 mm with M14 spindle thread.
- Mitre cuts up to 45°, adjustable vice and angle guard.
- Additional spark protection.
- Solid cast iron base plate construction.
- Spring loaded protective guard.



Description	Quantity	Id. No.	EAN Code
WS-T1	1	351790	201372

Technical data WS-T1

Description	
Vice opening	120 mm
Max. profile cuts with Ø disc 180 mm	30 x 110 mm
Max. pipe cuts with Ø disc 180 mm	40 mm
Max. profile cuts with Ø disc 230 mm	45 x 110 mm
Max. pipe cuts with Ø disc 230 mm	65 mm
Base plate	325 x 290 mm
Weight	13 kg
Supplied as standard: 2 clamping screws, spanner SW 17/21	



System accessories - Angle grinders

Description	AS 12 E SE 12-180 AP 12 E PE 150	For angle grinders with					Quantity	Id. No. 4932	EAN Code 4002395
		Ø 115	Ø 125	Ø 150	Ø 180	Ø 230			
① FIXTEC nut – M14 thread		●	●	●			1	352473	371327
② Flange nut M14		●	●	●	●	●	1	345628	313105
Flange nut		only for use on AG 25-230 Q					1	49050091	45242174102
③ Backing flange		●	●	●	●	●	1	449324	245185
④ Two hole spanner straight	●	●	●	●	●	●	1	367712	338467
⑤ Open-ended spanner SW 17/24	●	●	●	●	●	●	1	345710	307722
⑥ Cranked two hole spanner for steel wire brushes.	●	●			●	●	1	371469	342181
Dust protection grille			●	●			1	329397	303892
⑦ only suitable for old style grinders.					●	●	2	326525	303311
Side handle	●	●	●	●	●		1	409546	370870
					●	●	1	493143531	889259
⑧ Anti-Vibration side handle		●	●	●	● ¹⁾		1	399991	366507
					●	●	1	399992	366514
Hand protection guard	●						1	378478	347353
Flange nut set incl.:									
Flange nut M14 (345629)		Suitable for WS 2300 (Australia version)					1	351632	321636
Backing flange (371404)									
Large flange nut (367952)									

¹⁾ only for AGV 16-180 QXC.

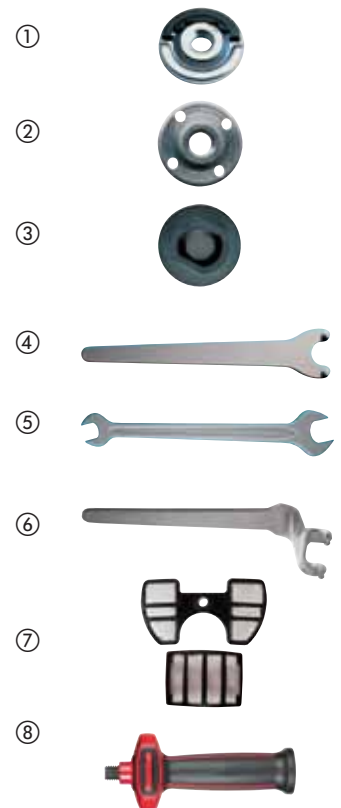

Flexible backing pads

Description	A	Ø mm	For angle grinders with				Quantity	Id. No. 4932	EAN Code 4002395
			Ø 115	Ø 125	Ø 180	Ø 230			
Flexible backing pad	14.2	110	●				1	345760	313488
Complete with flange nut	14.2	125		●			1	345761	313495
M14 for all angle grinders.	14.2	170			●		1	345758	313501
	22.2	170			●		1	352744	374021
Replacement flange nut M14			●	●	●	●	1	345627	313112

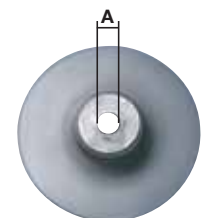

Cutting guards and dust extraction guards

Description	For angle grinders with					Quantity	Id. No. 4932	EAN Code 4002395
	Ø 115	Ø 125	Ø 150	Ø 180	Ø 230			
Guard with cutting guide								
① Fastening type: snap in clamping lever.	●	●				1	358948*	325818
Guard with cutting guide				●		1	399756*	365715
① Fastening type: snap in.								
Dust extraction guard set								
② Protection hood, guide block, hose connections, 4 m suction hose and adaptor.					●	1	399906	365616
Fastening type: snap in. Not suitable for WS 2100, AG 22.								
Suction hose						1	330552	312719
Ø 35 mm, 4 m long.								
Adaptor for direct connection								
③ of suction hose 330552.					●	1	430833	384952

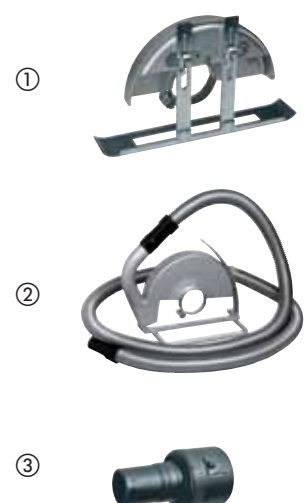

* while stocks last

Dust guards

NEW

Description	For angle grinders AG 12(v) & AG 15 series, M18 CAG		Quantity	Id. No. 4932	EAN Code 4002395
	Ø 115	Ø 125			
Dust Guard for cutting – DEC 125 100% tool free connection to Ø 115–125 mm AG(V) 12, AGV 15 series and FUEL [™] grinders, Keyless depth adjustment from 5–28 mm. Guide to prevent twisting during cutting Dust guard fits to the Milwaukee [®] M-Class cleaners with unique “click-system” adaptor supplied with the vacuum cleaner.	●	●	1	430467	381289
Dust Guard for surface conditioning – DEG 125 100% tool free connection to Ø 125 mm AG(V) 12 and AGV 15 series grinders. Supplied with additional loop handle. Removable magnetic front cover to gain access to tight corners and edges when using a cup wheel. Dust guard fits to the Milwaukee [®] M-Class cleaners with unique “click-system” adaptor supplied with the vacuum cleaner.		●	1	430468	381296



Abrasive discs - Hook & Loop

Perforated sanding discs for wood, metal, paint, lacquer, plaster.

Grit type: fused alumina, half-open. Artificial resin-bonded on special tear-resistant paper.

Ø 125 mm - 8 holes

Grit	Quantity	Paper size mm Ø	Id. No. 4932	EAN Code 4002395
40	5	125	367740	338610
60	5	125	367741	338627
80	5	125	367742	338634
120	5	125	367743	338641
180	5	125	367744	338658
240	5	125	367745	338665
40	25	125	371470	341870
60	25	125	371396	341665
80	25	125	371397	341672
120	25	125	371398	341689
180	25	125	371399	341696
240	25	125	371400	341702

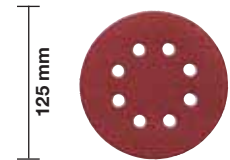

Ø 150 mm - 6 holes

Grit	Quantity	Paper size mm Ø	Id. No. 4932	EAN Code 4002395
40	5	150	371590	343171
60	5	150	371591	343188
80	5	150	371592	343195
120	5	150	371593	343201
180	5	150	371594	343218
240	5	150	371595	343225
40	25	150	371596	343232
60	25	150	371597	343249
80	25	150	371598	343256
120	25	150	371599	343263
180	25	150	371600	343270
240	25	150	371601	343287

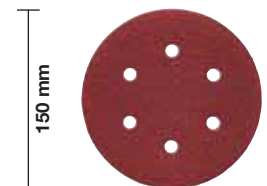

Abrasive sheets - Hook & Loop

Perforated sanding discs for wood, metal, paint, lacquer, plaster.

Grit type: fused alumina, half-open. Artificial resin-bonded on special tear-resistant paper.

80 x 133 mm

Grit	Quantity	Paper size mm A x B	Id. No. 4932	EAN Code 4002395
60	10	80 x 133	351666	319305
80	10	80 x 133	351667	319312
120	10	80 x 133	351668	319329
180	10	80 x 133	351669	319336
240	10	80 x 133	351670	319343

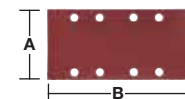

93 x 185 mm

Grit	Quantity	Paper size mm A x B	Id. No. 4932	EAN Code 4002395
80	10	93 x 185	345103*	312498

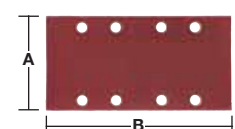

* while stocks last

Abrasive sheets - Clamp type

Perforated sanding discs for wood, metal, paint, lacquer, plaster.

Grit type: fused alumina, half-open. Artificial resin-bonded on special tear-resistant paper.

93 x 230 mm

Grit	Quantity	Paper size mm A x B	Id. No. 4932	EAN Code 4002395
50	10	93 x 230	305176	300006
80	10	93 x 230	305177	300013
100	10	93 x 230	305178	300020
150	10	93 x 230	305179	300037

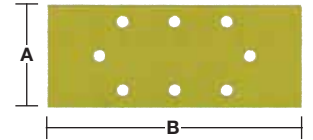

Abrasive sheets - Hook & Loop

Perforated sanding discs for wood, metal, paint, lacquer, plaster.

Grit type: fused alumina, half-open. Artificial resin-bonded on special tear-resistant paper.

105 x 105 mm

Grit	Quantity	Paper size mm A x B	Id. No. 4932	EAN Code 4002395
60	5	105 x 105	358492	324248
80	5	105 x 105	358493	324255
120	5	105 x 105	358494	324262
180	5	105 x 105	358495	324279
240	5	105 x 105	358496	324286

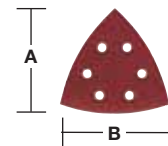

100 x 147 mm

Grit	Quantity	Paper size mm A x B	Id. No. 4932	EAN Code 4002395
60	10	100 x 147	355140	319992
80	10	100 x 147	355141	320004
120	10	100 x 147	355142	320011
180	10	100 x 147	355143	320028
240	10	100 x 147	355144	320035

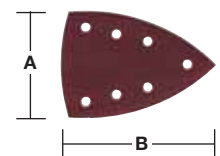

51 x 95 mm

Grit	Quantity	Paper size mm A x B	Id. No. 4932	EAN Code 4002395
60	5	51 x 95	358508*	324163
80	5	51 x 95	358509*	324170
120	5	51 x 95	358510*	324187

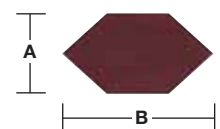

Abrasive belts

Cloth sanding belts for wood, metal, paint, lacqueur, plaster.

Grit type: fused alumina, half-open. Artificial resin-bonded on special fabric.

75 x 533 mm

Grit	Quantity	Paper size mm A x B	Id. No. 4932	EAN Code 4002395
40	5	75 x 533	312475	301263
60	5	75 x 533	312476	301270
80	5	75 x 533	312477	301287
100	5	75 x 533	312478	301294
150	5	75 x 533	312479	301300
240	5	75 x 533	312480	301317

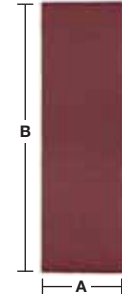

100 x 560 mm

Grit	Quantity	Paper size mm A x B	Id. No. 4932	EAN Code 4002395
40	3	100 x 560	312099	300419
60	3	100 x 560	312100	300426
80	3	100 x 560	312101	300433
100	3	100 x 560	312102	300440
150	3	100 x 560	312103	300457
240	3	100 x 560	312104	300464

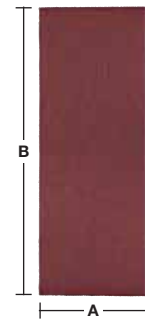

100 x 610 mm

Grit	Quantity	Paper size mm A x B	Id. No. 4932	EAN Code 4002395
40	5	100 x 610	355066	319824
60	5	100 x 610	355067	319831
80	5	100 x 610	355068	319848
100	5	100 x 610	355069	319855
150	5	100 x 610	355070	319862
240	5	100 x 610	355071	319879

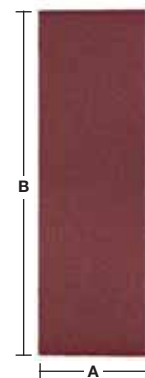

100 x 620 mm

Grit	Quantity	Paper size mm A x B	Id. No. 4932	EAN Code 4002395
40	5	100 x 620	341610	304882
60	5	100 x 620	341611	304899
80	5	100 x 620	341612	304905
100	5	100 x 620	341613	304912
150	5	100 x 620	341614	304929
240	5	100 x 620	341615	304936

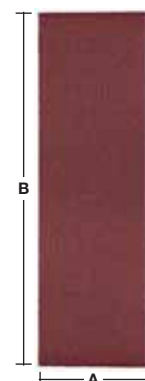

System accessories - Random orbital sanders

Description	Ø mm	EXE 400 TX 125	EXE 450 TXE 150 ROS 150 E	ROS 125 E	ROS 150	Qty.	Id. No. 4932	EAN Code 4002395
Base plate								
① Ø 125 mm, 8 holes	125	●		●		1	341268*	305117
Complete with rubber ring as spare.						1	430091	377527
Base plate								
① Ø 150 mm, 6 holes	150		●			1	357591*	343317
Complete with rubber ring as spare.						1	430145	378067
Clean Line System								
Frame with dust bag.	125			●		1+1	4931435448	889563
Frame with dust bag.	150				●	1+1	4931435911	874729
Spare paper bags for 345544.								
	-	●	●			5	4931442873	247882
Frame holder for dust bag 313096.								
	125/ 150	●	●			1	4931329719	610938
Dust bag (requires frame 4931329719).								
	125/ 150	●	●			1	313096*	302734
Lambswool polishing disc								
Application:								
Finishing high gloss polishing.	125	●		●		1	373159*	347919
Characteristics:	150		●		●	1	373164	347926
Natural lambs wool, very soft and adaptable, Hook & Loop fixation.								
Lambswool polishing disc								
100% natural lambswool								
Premium quality with extremely high fibre density for longer lifetime. Integrated SOFTTouch layer guarantees perfect adjustment to flat and curved profiles. For finishing old and fresh paint. Extremely good polishing of temperature sensitive clear lacquers thanks to heat resistant fibres, e.g. polishing car bumper.								
③	135	●		●		1	430395	380565
Polishing sponge								
Application:								
Polish up of weather-beaten lacquer, lacquer re-conditioning.	125	●		●		1	373160*	347933
	150		●		●	1	373165	347940
Characteristics:								
Medium hard, fine pored, with rounded edge, Hook & Loop fixation.								
Polishing sponge hard								
Hard sponge with coarse foam structure. For maximum removal of the reconditioning lacquer, removing deep scratches and polishing weather-beaten lacquer.								
⑤	145	●		●		1	430396	380572

①



②



③



④



⑤



System accessories - Orbital sanders

Description	VSS(E) 20	VSS(E) 22	VS 230 VSS(E) 260	Qty.	Id. No. 4932	EAN Code 4002395
① Dust bag with metal connector	●	●	●	1	313096*	302734
② Spare paper bags (5 pack) for Clean Line dust bag system 345547. Easy and clean replacement.	●	●	●	5	4931442873	247882
③ Dust bag – cloth, for use with Clean Line dust system 345547.	●	●	●	1	346182*	313273
④ Extraction hose Ø 26 mm, 4 m, for connection to external extraction system.	●	●	●	1	278824	308286

①



②



③



④



System accessories - Delta sanders

Description	DSE 260	VS 11 D FS 2 D	VS 11 FS 2	Qty.	Id. No. 4932	EAN Code 4002395
Sanding plate delta 105 x 105 mm	●			1	358439	324231
Hook & Loop sanding plate 80 x 133 mm		●		1	351674*	323067
Dust bag made of sturdy fabric.		●	●	1	351675	320103
Adaptor for hose Ø 26 mm.		●	●	1	351999	320110
Extraction hose Ø 26 mm, 4 m, for connection to external extraction system.		●	●	1	278824	308286

System accessories - Belt sanders

Description	HBS 65	HBSE 75 S	BS 100 S	BS 100 LE	BBS(E) 100	BBS(E) 1100	Quantity	Id. No. 4932	EAN Code 4002395
① Screw clamp (single piece) for stationary use on the work surface (2 units required).	●		●	●	●	●	1	367730	338566
② Extraction hose for connection to extraction system. Ø 26 mm, 4 m			●	●	●	●	1	278824	308286
③ Dust bag (spare)			●	●		●	1	336597	311026

①



②







③



* while stocks last

Premium polishing accessories - Hook & Loop Ø 125 mm

NEW

Description	Ø mm	Height	Qty	Id. No. 4932	EAN Code 4002395	
<p>Polishing backing pad with M14 thread</p> <p>① Very flat design with excellent flexibility. Low vibration allows precise work on any flat and curved profiles.</p>	125		1	430394	380558	① 
<p>Lambswool polishing disc 100% natural lambswool</p> <p>Premium quality with extremely high fibre density for longer lifetime. Integrated SOFTTouch layer guarantees perfect adjustment to flat and curved profiles. For finishing old and fresh paint. Extremely good polishing of temperature sensitive clear lacquers thanks to heat resistant fibres, e.g. polishing car bumper.</p>	135		1	430395	380565	② 
<p>Polishing sponge hard</p> <p>Hard sponge with coarse foam structure. For maximum removal of the reconditioning lacquer, removing deep scratches and polishing weather-beaten lacquer.</p>	145	30	1	430396	380572	③ 
<p>Polishing sponge soft</p> <p>Extremely soft sponge with fine foam structure. For fine polishing with polishing creams/wax compounds to remove very fine scratches and holograms (swirls).</p>	145	30	1	430397	380589	④ 
<p>Microfibre polishing cloth</p> <p>Super-soft premium microfibre polishing cloth for finishing gloss polishing. With good absorption properties perfectly suited for final finishing and removing water spots from sensitive surfaces. Machine-washable with 30° without softener.</p>	400 x 400	-	1	430398	380596	⑤ 
<p>Polish M-Cut 1500 (250 ml)</p> <p>A coarse 1500 grit polish for removing deep scratches without damaging the lacquer. Suitable for removing dust grains, orange peel texture, lacquer/paint runs and deep scratches. Free of wax, silicone and toxic solvents. Recommended for use with polishing sponge hard (4932430396) and lambs-wool polishing disc (4932430395).</p>			1	430475	381364	
<p>Polish M-Wax 6000 (250 ml)</p> <p>Premium high-tech wax with 6000 grit for removing fine scratches and sealing the paintwork in one step. Excellent performance in removing fine scratches/holograms/swirls. Contains the finest Brazilian Carnuba wax for long lasting mirror-like shine. Free of silicone. Recommended for use with polishing sponge soft (4932430397) and microfibre polishing cloth (4932430398).</p>			1	430476	381371	

Polishing accessories - Hook & Loop Ø 125/150 mm

Description	Ø mm	Height	Qty	Id. No. 4932	EAN Code 4002395
① Polishing backing pad with M14 thread	150	25	1	373161	347285
Felt polishing disc soft Second polishing/finish of new lacquer work, non-ferrous metals and stainless steel, can also be used with polishing paste.	125	50	1	373163	347902
③ Lambswool polishing disc Finishing high gloss polishing.	125 150	25 25	1 1	373159* 373164	347919 347926
Polishing sponge hard ④ Polish up of weather-beaten lacquer, lacquer re-conditioning.	125 150	50 50	1 1	373160* 373165	347933 347940
⑤ Polishing sponge soft Second polish of lacquer, lacquer care.	125 150	50 50	1 1	373184* 373186	347957 347964
⑥ Polishing sponge super-soft, profiled Polish up of lacquer, lacquer reconditioning, polishing of acrylic glass.	125 150	25 25	1 1	373185* 373187*	347971 347988



Polishing accessories - Spot polisher

NEW

Description	Ø mm	Height	Qty	Id. No. 4932	EAN Code 4002395
① Polishing/Sanding backing pad Thread: M9 x 0,75. Hook and loop fixation. For use with polishing sponges and abrasive paper.	76		1	430488	381494
② Polishing sponge - Hard (yellow) Hard sponge for use with more aggressive polish for removal of deep scratches. Hook and loop fixation. For use with polishing/sanding backing pad.	80	25	1	430489	381500
③ Polishing sponge - Soft (white) Soft sponge for use with light polish for removal of small scratches. Hook and loop fixation. For use with polishing/sanding backing pad.	80	25	1	430490	381517
④ Lambswool polishing pad Hook and loop fixation. For use with polishing/sanding backing pad.	87 80		1 1	430491 430837	381524 384990
⑤ Fibre disc backing pad Thread: M9 x 0,75 to affix to tool. Knurled thread to fix coated abrasives and surface finishing products for coarse sanding applications, such as rust removal. Ideal for sanding small or awkward to reach areas such as pinch welds, door shuts and wheel arches.	46		1	430492	381531



* while stocks last

SAWZALL[®] blades

Shank reception

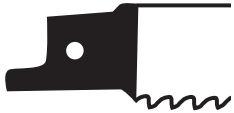

1/2" Universal shank

Suitable for the brands AEG, B&D, Bosch, DeWalt, Fein, Flex, Hilti, Makita, Metabo, Milwaukee[®], Porter Cable, Ridgid, Rothenberger, Ryobi, Skil.

Material qualities

To ensure maximum performance and lifetime, a number of different raw materials are used in the production of sabre saw blades. The raw material depends on the eventual application.

Bi-Metal

■ Bi-Metal blade. With high quality M2 steel cutting edge for all Heavy Duty applications.

Bi-Metal, Co

■ Bi-Metal blade with 8% cobalt. With premium Matrix II steel cutting teeth (with 8% cobalt content), the ultimate in performance and lifetime.

HCS

■ High carbon steel. Mostly suited to cutting wood and plastics.

Stainless

■ Stainless steel. Corrosion resistant blade.

TC

■ Carbide grit. For cutting cast iron pipes and abrasive materials.

■ Carbide tipped teeth. Suitable for glass fibre reinforced products and soft building blocks.

Bi-Metal blades consist of a hardened high speed steel cutting edge electron-beam welded onto a flexible alloy steel back. Bi-Metal blades are tougher, flexible reducing breakages, faster cutting and last longer than conventional carbon and all high speed steel blades. Those blades with cobalt have even harder teeth and offer double the lifetime in metal cutting applications and five times the lifetime over conventional high carbon steel blades.

The Milwaukee[®] advantage



SAWZALL[®] Blades

- Up to 50% longer life
 - Unique cryogenic heat treatment process provides tougher teeth for extreme applications
 - Excellent cutting performance and lifetime in difficult materials such as stainless steel
- ✓ Upto 65 HRC tooth hardness with cobalt for the most demanding applications in all metals and high alloy steels.
 - ✓ The blade body has a high level of elasticity and significantly reduces the risk of blade breakage.
 - ✓ Matrix II Bi-Metal strip with 8% cobalt teeth can endure high wear rates and is very heat resistant ensuring longer life.

Comparative test in 100 mm steel pipe

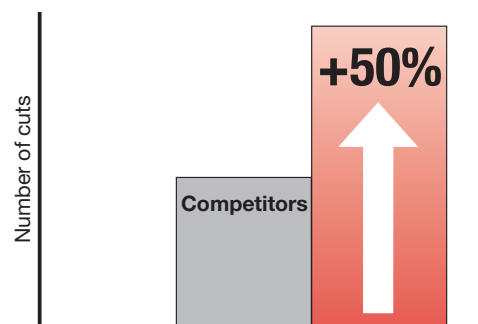

Milwaukee[®] SAWZALL[®] blades cut more!



Blade shapes

SAWZALL® blades can be manufactured in many various shapes. The shape is adjusted to the application. The thickness of the blade depends on the required flexibility. More demanding applications like cutting tubes require thick blades, less demanding applications require thin, narrow blades.

The blade shapes can be divided into four different groups:

1. Universal blades



The universal blade is for general use. Its even width guarantees good cutting stability and excellent guidance. This enables straight edge cutting through many different materials.

3. Scroll blades



These blades are especially used for curve cutting. The more narrow the blade, the smaller a radius can be cut.

2. Sloped blades



Sloped blades are commonly used when cutting wood and demolition applications. The narrow tip allows for plunge cuts and curve cutting. This shape is rarely used when working in metal, since the tip does not have the necessary strength required for this application.

4. Special scroll blades



Special scroll blades were developed for both straight and curve cutting in soft material like plaster-board. The blade is wide at the rear (for straight cutting) and narrow at the front (for curve cutting).

Packaging

Our SAWZALL® blade packaging is totally language free, technical characteristics and applications are clearly illustrated for easy self-service. Blades are offered in two forms of packaging, a economic pack and for the industrial users a bulk pack container. Both forms of packaging can be reused as a storage facility for used blades.



Tooth geometry

The blade length (A) represents the complete length of the blade – A.

The tooth pitch is shown in millimetres (mm) and in inches.

Tooth pitch in mm

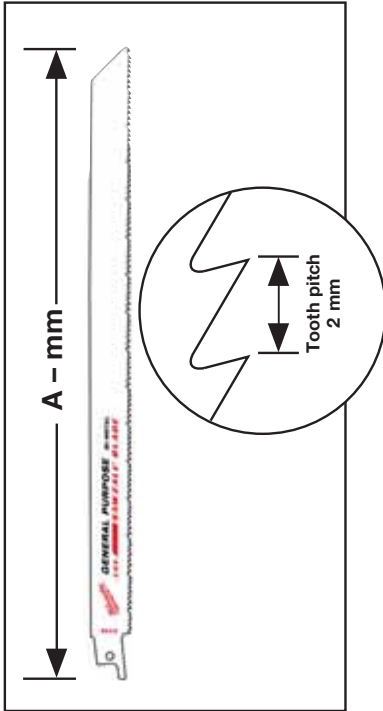

Teeth per inch

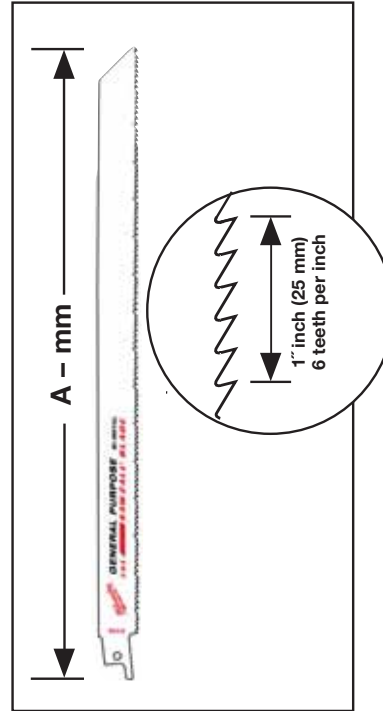

To attain the correct blade length, it is necessary to take the width of material to be cut and add an extra 80 mm. Selecting the correct tooth pitch for the material being cut is dependent on the thickness of the material being cut, this is extremely important when cutting metals to ensure the blade is used to its optimum performance. The golden rule is to have three teeth in contact with the material being cut at all times. When cutting wood the higher the tooth pitch in mm's (the lower in inches) the rougher and coarser the cut will be.





For cutting metal the following table can be used for guidance.

Material – All metals – Tubing/profiles/channels	Tooth pitch (mm)	Teeth per inch
Wall thickness 4.5 mm to 10 mm	1.8	14
Wall thickness 3.0 mm to 4.5 mm	1.4	18
Wall thickness less than 3 mm (thin materials)	1.0	24

Application guidelines

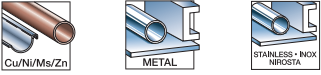

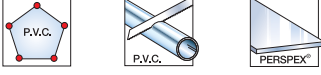



Cut Cool – Cut Faster – Cut Longer

To ensure longer life, it is recommended to use a cooling lubricant, which can result in extending the life of the saw blade by up to 500%.

Material	Coolant
	Cutting oil
	Turpentine
	Compressed air
	Water
	Dry

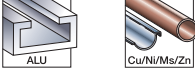
Cutting Speed Recommendation

The following table can be used as a rough guide, however the material wall thickness must also be considered when deciding on the correct speed.

Material	Speed – max. strokes per minute
 <p>Less than 600 N/mm² strength</p>	2000
 <p>Between 600 N/mm² – 800 N/mm² strength</p>	1500
 <p>Over 800 N/mm² strength</p>	500
	1500
	1000
	500
	2000 – 2800

Wood and plastics

Blade length mm	Tooth pitch mm	Teeth per inch	Material type	Ref. No.	Qty.	Id. No.	UPC Code 45242	Material thickness – mm				
	150	4.2	6	HCS	S644D	3	48001075	079810	6-100	6-100	●	
	150	4.2	6	HCS	S744D	3	48001076	079827	6-50	6-50	●	
	230	4.2	6	Bi-Met,Cc	-	5	48005016	082636	6-190	6-190	6-100	●
	240	5.5/6	4/5	HCS	S1531L	3	48001077	079834	15-190	15-190		
	240	8.5	3	HCS	S1542K	3	48001078	079841	15-190			
	300	4.2	6	HCS	S1344D	3	48001079	079858	6-250			

Wood with nails: THIN KERF demolition blades

FANG TIP™ NAIL GUARD™

For faster plunge cutting and reaching into restricted areas.



Protects the tooth during nail impacts for increased durability and lifetime.



- **Strong:** 1,25 mm thick blade body for good strength and blade life making it ideal for wood with nails or bolts.
- **Fast:** aggressive 5 TPI geometry removes more material per stroke for faster cutting.
- **Sloped shape:** excellent for plunge cutting and reaching into restricted areas.
- **Shatter resistant:** Bi-Metal construction allows the blade to bend and flex without breaking.

Blade length mm	Tooth pitch mm	Teeth per inch	Material type	Ref. No.	Qty.	Id. No.	UPC Code 45242	Material thickness – mm						
	150	5	5	Bi-Met,Cc	S611DF	5	48005035	082698	10-100	10-100	Ø 10-100	10-50	●	●
	230	5	5	Bi-Met,Cc	S1111DF	5	48005036	082704	10-175	10-175	Ø 10-175	10-50	●	●
	300	5	5	Bi-Met,Cc	S1411DF	5	48005037	082711	10-250	10-250	Ø 10-250	10-50	●	

Wood with nails: Heavy Duty AX demolition blades

THE AX™

FANG TIP™ For faster plunge cutting and reaching into restricted areas.



NAIL GUARD™ Protects the tooth during nail impacts for increased durability and lifetime.



- **Strong:** extra thick 1.60 mm body for maximum robustness and life making it ideal for wood with nails or bolts.
- **Fast:** aggressive 5 Tpi tooth geometry removes more material per stroke for faster cutting.
- **Sloped shape:** excellent for plunge cutting and reaching into restricted areas.
- **Shatter resistant:** Bi-Metal construction allows the blade to bend and flex without breaking.

Blade length mm	Tooth pitch mm	Teeth per inch	Material type	Ref. No.	Qty.	Id. No.	UPC Code 45242							
-----------------	----------------	----------------	---------------	----------	------	---------	----------------	--	--	--	--	--	--	--

Material thickness – mm

	150	5	5	Bi-Met,Co	-	5	48005021	082988	10-100	10-100	Ø 10-100	10-50	●	●	●
						25	48008021	082285							

	230	5	5	Bi-Met,Co	-	5	48005026	082995	10-175	10-175	Ø 10-175	10-50	●	●	●
						25	48008026	082292							

	300	5	5	Bi-Met,Co	-	5	48005027	083022	10-250	10-250	Ø 10-250	10-50	●	●	●
						25	48008027	082308							

Wood/Metal/Plastic: Universal blades

Blade length mm	Tooth pitch mm	Teeth per inch	Material type	Ref. No.	Qty.	Id. No.	UPC Code 45242							
-----------------	----------------	----------------	---------------	----------	------	---------	----------------	--	--	--	--	--	--	--

Material thickness – mm

	150	2.5	10	Bi-Met,Co	-	5	48005092	082766	3-10	3-10	5-50	3-10	5-50	●	Ø 3-50	10-50
						50										

	150	2.5/1.8	10/14	Bi-Met,Co	S922VF	5	48005292	084067	3-10	3-10	5-100	3-10	5-100	●	Ø 3-100	10-50
						50	48016292	084081								

	200	2.5/1.8	10/14	Bi-Met,Co	-	5	48005293	084074	3-10	3-10	5-175	3-10	5-175	●	Ø 3-160	10-50
						50	48016293	084098								

	300	2.5/1.8	10/14	Bi-Met,Co	-	5	48005194	082926	3-10	3-10	5-250	3-10	5-250	●	Ø 3-250	10-50
						50										

	150	3.2/2.1	8/12	Bi-Met,Co	-	5	48005091	082759	3-10	3-10	5-100	3-10	5-100	●	Ø 3-100	10-50
						50	48016091	084685								

	200	3.2/2.1	8/12	Bi-Met,Co	-	5	48005093	082773	3-10	3-10	5-175	3-10	5-175	●	Ø 3-160	10-50
						50	48016093	084708								
						500	48016000	084951								

	300	3.2/2.1	8/12	Bi-Met,Co	-	5	48005094	082780	3-10	3-10	5-250	3-10	5-250	●	Ø 3-250	10-50
						50	48016094	084715								

Metal: THIN KERF blades



DOUBLE DUTY UPGRADE



Improved tooth geometry for best speed and double the lifetime. Bi-Metal quality cutting teeth with 8% Cobalt the ultimate in performance and lifetime.



Stamped indentations around the reception strengthens the blade at its weakest point.

THIN KERF















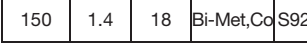

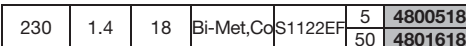
Slim 0.90 mm thick blade body optimised for maximum speed and flexibility.

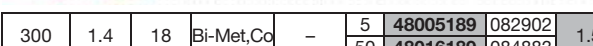

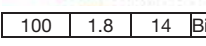
Unique cryogenic heat treatment process gives
 – tougher teeth for cutting the hardest of metals
 – up to 50% longer life.

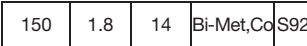

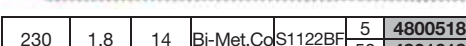
Metal: THIN KERF blades

Blade length mm	Tooth pitch mm	Teeth per inch	Material type	Ref. No.	Qty.	Id. No.	UPC Code 45242	Material wall thickness – mm							
								METAL	METAL	METAL	Cu/Ni/Ms/Zn	STAINLESS-INOX NIRÖSTA	ALU		
	100	1	25	Bi-Met,Cc	S522AF	5	48005185	082865	0.5-3	0.5-3	Ø 8-50	0.5-3	0.5-3		
	150	1	25	Bi-Met,Cc	S922AF	5	48005186	082872	0.5-3	0.5-3	Ø 8-100	0.5-3	0.5-3		
	100	1.4	18	Bi-Met,Cc	S522EF	5	48005183	082841	1.5-4	1.5-4	Ø 10-50	1.5-4	1.5-4		
	150	1.4	18	Bi-Met,Cc	S922EF	5	48005184	082858	1.5-4	1.5-4	Ø 10-100	1.5-4	1.5-4		
							48016184	084739							
	150	1.4	18	Bi-Met,Cc	S922EF	5	48004184	081042	1.5-4	1.5-4	Ø 10-100	1.5-4	1.5-4		
	230	1.4	18	Bi-Met,Cc	S1122EF	5	48005188	082896	1.5-4	1.5-4	Ø 10-160	1.5-4	1.5-4		
							48016188	084876							
	230	1.4	18	Bi-Met,Cc	S1122EF	5	48004188	081066	1.5-4	1.5-4	Ø 10-160	1.5-4	1.5-4		
	300	1.4	18	Bi-Met,Cc	-	5	48005189	082902	1.5-4	1.5-4	Ø 10-180	1.5-4	1.5-4		●
							48016189	084883							
	90	1.8	14	Bi-Met,Cc	S422BF	5	48005162	082803	1.5-6	1.5-6		1.5-4	1.5-6	●	
	100	1.8	14	Bi-Met,Cc	S522BF	5	48005181	082827	3-10		Ø 10-50	3-10	2-4	3-10	
															
	150	1.8	14	Bi-Met,Cc	S922BF	5	48005182	082834	3-10		Ø 10-100	3-10	2-4	3-10	
							48016182	084722							
	150	1.8	14	Bi-Met,Cc	S922BF	5	48004182	081035	3-10		Ø 10-100	3-10	2-4	3-10	
	230	1.8	14	Bi-Met,Cc	S1122BF	5	48005187	082889	3-10		Ø 10-160	3-10	2-4	3-10	
							48016187	084869							
	230	1.8	14	Bi-Met,Cc	S1122BF	5	48004187	080991	3-10		Ø 10-160	3-10	2-4	3-10	

Metal: Heavy Duty demolition blades

THE TORCH™

STIFFEST



STRONGEST



LONGEST



Improved tooth geometry for best speed and double the lifetime.
 Thick 1,06 mm robust blade body for precise cuts.
 25 mm blade height for improved stability and minimum vibration.
 Bi-Metal quality cutting teeth with 8 % Cobalt the ultimate in performance and lifetime.



Stamped indentations around the reception strengthens the blade at its weakest point.





















A grid iron pattern is built into the blade to make it more rigid with less tendency to bend or buckle for best durability and straight cuts.



Unique cryogenic heat treatment process gives
 – tougher teeth for cutting the hardest of metals
 – up to 50% longer life.



Metal: Heavy Duty demolition blades

Blade length mm	Tooth pitch mm	Teeth per inch	Material type	Ref. No.	Qty.	Id. No.	UPC Code 45242													
														Material wall thickness – mm						
														2-8	Ø 10-100	2-8	2-4	●		
150	1.4	18	Bi-Met,Co	-	5	48005784	083084													
					25	48008784	082407													
 														2-8	Ø 10-100	2-8	2-4	●		
150	1.4	18	Bi-Met,Co	-	5	48004784	081110													
														2-8	Ø 10-160	2-8	2-4	●		
230	1.4	18	Bi-Met,Co	-	5	48005788	083091													
					25	48008788	082421													
 														2-8	Ø 10-160	2-8	2-4	●		
230	1.4	18	Bi-Met,Co	-	5	48004788	081134													
														2-8	Ø 10-180	2-8	2-4	●		
300	1.4	18	Bi-Met,Co	-	5	48005789	083107													
					25	48008789	082438													
														3-10	Ø 10-100	3-10	3-7	●	●	
150	1.8	14	Bi-Met,Co	-	5	48005782	083060													
					25	48008782	082391													
 														3-10	Ø 10-100	3-10	3-7	●	●	
150	1.8	14	Bi-Met,Co	-	5	48004782	081097													
														3-10	Ø 10-160	3-10	3-7	●	●	
230	1.8	14	Bi-Met,Co	-	5	48005787	083077													
					25	48008787	082414													
 														3-10	Ø 10-160	3-10	3-7	●	●	
230	1.8	14	Bi-Met,Co	-	5	48004787	081127													
														4-10	Ø 10-100	4-10	4-10	●	●	
150	2.5	10	Bi-Met,Co	-	5	48005712	083039													
					25	48008712	082377													
 														4-10	Ø 10-100	4-10	4-10	●	●	
150	2.5	10	Bi-Met,Co	-	5	48004712	081073													
														4-10	Ø 10-160	4-10	4-10	●	●	
230	2.5	10	Bi-Met,Co	-	5	48005713	083046													
					25	48008713	082384													
 														4-10	Ø 10-160	4-10	4-10	●	●	
230	2.5	10	Bi-Met,Co	-	5	48004713	081080													

Metal: Extra Heavy Duty

THE WRECKER[™]

- **Strong and precise:** extra thick 1.60 mm blade body.
- **Bi-Metal construction:** excellent blade life and performance.
- **Tooth geometry:** aggressive strengthened tooth tip design and uniform gullet depth allows for more material to be removed per stroke for faster cutting.
- **Blade shape:** sloped – The sloped shape makes this blade ideal for plunge cutting. Most suited for cutting metal and for demolition applications (wood with nails).

Blade length mm	Tooth pitch mm	Teeth per inch	Material type	Ref. No.	Qty.	Id. No.	UPC Code 45242	METAL	METAL	Cu/Ni/Ms/Zn	STAINLESS-INOX NROSTA	Material thickness – mm			
-----------------	----------------	----------------	---------------	----------	------	---------	----------------	-------	-------	-------------	-----------------------	-------------------------	--	--	--



150	3.2	8	Bi-Met,Co	-	5	48005701	082476	4-10	Ø 10-100	4-10	4-10	●	●	●	
-----	-----	---	-----------	---	---	----------	--------	------	----------	------	------	---	---	---	--



230	3.2	8	Bi-Met,Co	-	5	48005706	082483	4-10	Ø 10-160	4-10	4-10	●	●	●	
-----	-----	---	-----------	---	---	----------	--------	------	----------	------	------	---	---	---	--



300	3.2	8	Bi-Met,Co	-	5	48005711	082490	4-10	Ø 10-180	4-10	4-10	●	●	●	
-----	-----	---	-----------	---	---	----------	--------	------	----------	------	------	---	---	---	--

SAWZALL[®] sets

9pc SAWZALL[®] Universal blade set with storage container

Contains	Length mm	Tooth pitch - Tpi	Application	Id. No.	UPC Code 45242
2	150	5	Demolition – wood with nails (48005035)	49221145	043521
1	230	5	Demolition – wood with nails (48005036)		
3	150	14	Metal 3–10 mm (48005182)		
3	150	24	Metal thin 0,5–3 mm (48005186)		









12pc SAWZALL[®] Demolition blade set with storage container

Contains	Length mm	Tooth pitch - Tpi	Application	Id. No.	UPC Code 45242
2	150	5	AX Demolition – wood with nails (48005021)	49221129	180813
2	230	5	AX Demolition – wood with nails (48005026)		
2	150	8	Wrecker Metal straight cuts 4–10 mm (48005701)		
2	230	14	Torch Metal 3–10 mm (48005787)		
4	150	18	Torch Metal 2–8 mm (48005784)		





SAWZALL® blades for special materials

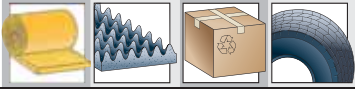

Special application: cast iron/abrasive materials/fibreglass

Blade length mm	Tooth pitch mm	Teeth per inch	Material type	Ref. No.	Qty.	Id. No.	UPC Code 45242					
								Material thickness – mm				
230	Coarse		Diamond	-	1	48001450	187416	Ø 10-160	Ø 10-160	3-175		
												
150	Coarse		TC	-	3	48001420	081950	Ø 10-100	Ø 10-100	3-100		
												
230	Coarse		TC	S1130R	3	48001430	082001	Ø 10-160	Ø 10-160	3-175		
												
305	8.5	3	TC	S1241HM	1	48001080	079865			6-150	10-250	
												
450	17.0	1.5	TC	-	1	48001460	235353			6-150	10-350	10-350

Special application: insulation material/carton/foam

Blade length mm	Tooth pitch mm	Teeth per inch	Material type	Ref. No.	Qty.	Id. No.	UPC Code 45242					
												
300	wave/knife	wave/knife	HCS	-	1	48001084	079902	●	●	●	●	

Special application: frozen materials

												
300	4.2	6	Stainless	S1211K	1	48001082	079889					
												
400	4.2	6	Stainless	-	1	48001083	079896					

Special application: flush cut blade



- **Flush cuts against floor:** floor guard protects teeth from floor contact when cutting flush to the floor.
- **Extra tall blade body:** guides blade for straighter cuts ie. when cutting out doors and windows in wood construction.
- **FANGTIP™** – for easy and quick plunging.
- Suitable for cutting all types of wood and nail embedded wood. Not suitable for brick, masonry or steel.

300	5	5	Bi-Met,Co	-	1	48001600	253272					
-----	---	---	-----------	---	---	----------	--------	--	--	--	--	--

Special application: ductwork blade

- **Plunge tip:** fast plunging in materials < 0,6 mm. No need for extra tools.
- **Versatility:** tapered blade body profile allows for tight radius cutting and square cuts.
- **Longlife:** optimized tooth geometry 30 tpi for cutting thin material 0,6–1,5 mm. Most common spiral duct is 0,8 mm thick.

Blade length mm	Tooth pitch mm	Teeth per inch	Quantity	Id. No.	UPC Code
85	0.8	30	5	48001630	300174



Special application: drywall/plasterboard blade



- **Precise depth of cut:** only 63 mm long, protects from unintentional cuts in pipes or wiring.
- **Double sided teeth:** cuts in ALL directions – produces less dust than jobsaw handtool – cuts clean without ripping the drywall.
- **Plunge tip:** fast and effortless plunging.

Blade length mm	Tooth pitch mm	Teeth per inch	Quantity	Id. No.	UPC Code		
63	–	–	1	48001640	300181	●	●

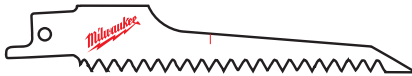

125	4.2	6	5	48005052	082735	●	●
-----	-----	---	---	----------	--------	---	---

System accessories - SAWZALL®



	Id. No.	UPC	SSE 1000 AVS	SSE 1000 SQ	SSE 1000 QX	SSPE 1000 QX	SSD 1100 X	SSPE 1300 QX	M18 FUEL™ SAWZALL	SSDE 1500 X	SSPE 1300 SQ	SSH 800 QX Hatchet	PSH 18 – 18 V Hatchet	PSX 18	V18 SX / V28 SX	USE 980 X	USE 900	SSPE 1500 X
Heavy Duty cast iron pipe clamp with round fixing post (part no. 45160611). Capacity 4"/110 mm.	49221012*	180394	●	●														
Heavy Duty cast iron pipe clamp with fixing post (part no. 45160613). Capacity 4"/110 mm.	49221024*	180493				●						●	●					
Heavy Duty cast iron pipe clamp with fixing post (part no. 45160604). Capacity 4"/110 mm.	49221016*	181445						●			●				●	●		●
Conversion kit: to convert FIXTEC blade reception models to keyed blade reception to accept 20 mm reception blades.	42680685 clamp + 06832976 screw + 49960070 Hex key				●	●		●			●	●	●		●	●		
Conversion kit: To convert FIXTEC blade reception models to keyed blade reception to accept 1/2" universal reception blades.	49225016 clamp + 06832976 screw + 49960070 Hex key				●	●		●			●	●	●		●	●		
Conversion kit: To convert standard 1/2" keyed blade reception models to keyed blade reception to accept 20 mm reception blades.	42680647 clamp + 06832960 screw + 49960080 Hex key		●								●							
Transport case in plastic.	48556510 201602001	148424 4002395836383	●	●	●	●		●			●				●			
Transport case in ABS plastic – requires insert tray.	4932378986	349041											●					

HACKZALL blades

- Especially engineered blades for exclusive use on 12 V HACKZALL.
- Bi-Metal construction for increased tooth durability.
- Optimised tooth form for aggressive and faster cutting.
- Thinner blade body for better speed of cut and 35% more cuts per charge.

Blade length mm	Tooth pitch mm	Teeth per inch	Material type	Quantity	Id. No.	UPC Code 45242	Material thickness - mm											
																		



100	4.2	6	Bi-Met,Co	5	49005460	160273							6-40	Ø 10-40				
-----	-----	---	-----------	---	----------	--------	--	--	--	--	--	--	------	---------	--	--	--	--



150	1.8	14	Bi-Met,Co	5	49005614	160334	3-6	Ø 10-32	3-6	3-6				Ø 10-50				
-----	-----	----	-----------	---	----------	--------	-----	---------	-----	-----	--	--	--	---------	--	--	--	--



100	1.4	18	Bi-Met,Co	5	49005418	160341	1.5-4	Ø 10-32	1.5-4									
-----	-----	----	-----------	---	----------	--------	-------	---------	-------	--	--	--	--	--	--	--	--	--



100	1	25	Bi-Met,Co	5	49005424	160358	0.5-3	Ø 8-32	0.5-3									
-----	---	----	-----------	---	----------	--------	-------	--------	-------	--	--	--	--	--	--	--	--	--



75 mm scraper: for removing strong adhesive silicon, caulk, paint and rust

75	-	-	-	1	49005456	219476												
----	---	---	---	---	----------	--------	--	--	--	--	--	--	--	--	--	--	--	--

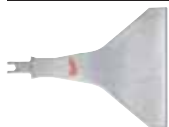

125 mm wide scraper: for removing glue, silicon, caulk, vinyl, rust, paint and wallpaper.

125	-	-	-	1	49005455	293421												
-----	---	---	---	---	----------	--------	--	--	--	--	--	--	--	--	--	--	--	--



Grout removal blade: for removing damaged or moulded grout between tiles

60	-	-	-	1	49005450	221066												
----	---	---	---	---	----------	--------	--	--	--	--	--	--	--	--	--	--	--	--



10pc Set: contains 2x 49005460, 3x 49005614, 3x 49005424, 2x 49005418 + storage pouch				10	49220220	160365												
--	--	--	--	----	----------	--------	--	--	--	--	--	--	--	--	--	--	--	--

Jigsaw blades

Material qualities

HCS

- High Carbon Steel jigsaw blades are used for cutting all types of wood and plastics.

HSS

- High Speed Steel blades are suited to cutting metal, non ferrous metal and aluminium.

Carbide grit

- These blades have a tungsten carbide grit edge making them suitable for abrasive materials.

TC

- Blades with tungsten carbide tipped teeth are ideally suited to glassfibre reinforced products. Those blades with a continuous tungsten carbide tooth strip cutting edge are suitable for extremely hard materials such as stainless steel.

Bi-Metal

- Bi-Metal blades consist of high speed steel teeth electron beam welded onto a flexible alloy steel back. These blades offer maximum performance in the most demanding applications in both wood and metal.

Bi-Metal blades offer the following benefits:

- Flexible and shatter resistant
- Longer lifetime. Metal cutting blades offer double the lifetime and wood cutting blades more than 5 times the lifetime over conventional HCS and HSS blades.
- High wear rate and heat resistance ensure the teeth stay sharp longer.
- Faster cutting performance.

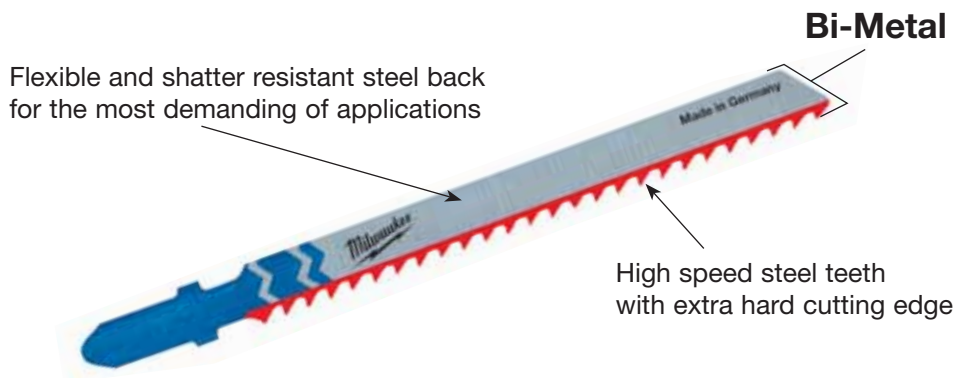

Blade colour code

Shank colour means application



= For all types of wood, laminated chipboard, chipboard, plywood, blockboard and plastics. Silver colour blade body.



= For all types of ferrous and non-ferrous metals, steel, aluminium, brass, copper, stainless steel, lead, tin and sandwich materials. Silver colour blade body.



= For cutting a range of products, carton, rubber, fibreglass, foam and abrasive materials. Black colour blade body.



= Bi-Metal blades come with a white body and then the corresponding colour shank; yellow for wood and blue for metal.

Shank receptions

T-Shank blades

- Suitable for most major brands.
AEG, Bosch, DeWalt, Festool, Hitachi, Hilti, Mafell, Makita, Metabo, Milwaukee®, Ryobi.



Special shank blades

- We do also offer a range of the most popular blades with either the Makita, or U-Shank reception.

U-Shank: for Black & Decker, Kress, Ryobi, Skil



Packaging



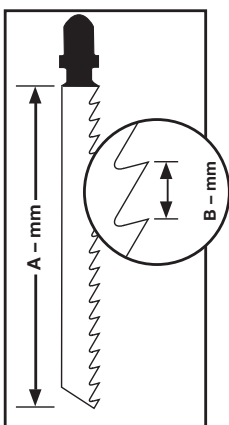

- Common blades are available in 5 and bulk 25 pack quantities. Our 25 pack packaging is reusable allowing for blades to be removed and returned easily.
- Our colour system on the blades is also featured on our packaging in conjunction with our pictograms to ensure you have the right blade for the application.

Technical tips

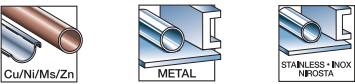

- The blade length represents the section of the blade with cutting teeth (A-mm). The tooth pitch is measured in millimetres (mm) from tooth point to tooth point (B-mm). Selecting the correct tooth pitch is dependent on the thickness of material being cut. The golden rule is to have three teeth in contact with the material being cut at all times; this is the optimum, as a guidance for thick material such as metals over 4 mm thickness a tooth pitch of 2 mm or more is recommended. For metals with a thickness of 1.5–3.5 mm a tooth pitch of 1.2 to 1.4 is desirable. When cutting thin metal sheet material below 1.5 mm a tooth pitch of 0.7 to 1.2 mm is recommended. The general rule when cutting wood is the higher the tooth pitch the faster and rougher/coarser the cut will be.
- When cutting extremely thin sheet material it is recommended to place the material onto a thicker backing to prevent the sheet material from breaking.
- We recommend the use of a cooling lubricant to extend the life of the saw blade when cutting metals and plastics.

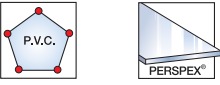
Material	Coolant
	Cutting oil
	Turpentine
	Water

Jigsaw blades for wood and plastic



T-Shank Blades

Blade length (toothed) mm	Tooth pitch mm	Ref. No.	Qty.	Id. No. 4932	EAN Code 4002395						
Depth of cut in mm											

Traditional blades

Traditional blades that deliver good and solid performance.



50	2	T 119 B	5	274353	301553	< 20	< 20	●			
----	---	---------	---	--------	--------	------	------	---	--	--	--



75	3	T 111 C	5	254071	301539	5-50	< 40	●			
----	---	---------	---	--------	--------	------	------	---	--	--	--

Curve cutting blades

All our curve cutting blades are characterised by a narrow blade body for improved manoeuvrability.

Jigsaw blade 4932265312 and 4932430143 has cutting teeth on both sides.

The teeth on the back of the blade allows one to cut tight and acute curves with simplicity.

For best results work without pendulum action when cutting tight curves.



50	1.35	T 101 AO	5	373392	348879	< 20	< 20	< 15	●	●	
----	------	----------	---	--------	--------	------	------	------	---	---	--



50	2	T 119 BO	5	274650	301485	< 20	< 20	●	●		
----	---	----------	---	--------	--------	------	------	---	---	--	--



75	2.5	Curve	5	430143	378043	< 30	< 20	< 20	●	●	●
----	-----	-------	---	--------	--------	------	------	------	---	---	---



75	4/1.2	SPECIAL	5	265312	301478	< 30	< 30	●	●		
----	-------	---------	---	--------	--------	------	------	---	---	--	--



75	4	T 244 D	5	346078	312375	< 50			●	●	●
			25	373492	349920						

Fast cut blades

The sharp and aggressive tooth geometry is ideal for very fast cutting of wood.



75	4	T 144 D	5	213116	301492	< 50			●		●
			25	373487	349272						
			100	430461	381227						



Bi-Metal	75	4	T 144 DF	5	373391	348862	< 50			●	●
-----------------	----	---	----------	---	--------	--------	------	--	--	---	---



105	4	T 344 D	5	311633	301508	< 80			●	●	
-----	---	---------	---	--------	--------	------	--	--	---	---	--



155	4	T 744 D	5	354745	324095	5-125			●	●	
-----	---	---------	---	--------	--------	-------	--	--	---	---	--

Blade length (toothed) mm	Tooth pitch mm	Ref. No.	Qty.	Id. No. 4932	EAN Code 4002395										
Depth of cut in mm															

Fast and clean cutting blade

Triple sharpened tooth geometry for fast and super clean splinter free cuts. Plunge tip for fast plunging.



3 cut	91	2.5	T 234 X	5	430141	378029	3-60	3-60	●	< 45					
--------------	----	-----	---------	---	---------------	--------	------	------	---	------	--	--	--	--	--

Clean and splinter free cutting blades

The following blades have diagonally sharpened side set teeth resulting in a very clear splinter free cut.



75	2.5	T 101 B	5	254061	301522	< 30	< 60	< 30	●						
			25	373489	349296										



Bi-Metal	75	2.5	T 101 BF	5	373390	348855	< 30	< 60	< 30	●					
-----------------	----	-----	----------	---	---------------	--------	------	------	------	---	--	--	--	--	--



75	4	T 101 D	5	274351	301515	< 50	< 60	< 45	●						
			25	373490	349906										



105	3	T 301 CD	5	399306	359202	< 80	< 60		●						
-----	---	----------	---	---------------	--------	------	------	--	---	--	--	--	--	--	--



105	4	T 301 DL	5	346071	312399	< 80	< 80	< 50	●						
-----	---	----------	---	---------------	--------	------	------	------	---	--	--	--	--	--	--

Precise straight cutting blades: kitchen worktops

The following blades benefit from a thicker blade body guaranteeing extra stiffness and consequently a more accurate vertical cut. Ideal for those applications where a true square cut is necessary – i.e. kitchen worktops.



75	4	T 101 DP	5	373080	346073	< 60	< 60	< 45	●			●			
----	---	----------	---	---------------	--------	------	------	------	---	--	--	---	--	--	--



105	4	T 101 DPsp.	5	373388	348831	< 80	< 80	< 50	●			●			
-----	---	-------------	---	---------------	--------	------	------	------	---	--	--	---	--	--	--

Special application: kitchen worktops and laminated chipboard

These blades have a reversed tooth design, this means that the blade cuts on the downward stroke making them extremely suitable for clean and splinter free cuts in laminated chipboard and especially kitchen worktops in situ. For best results work without pendulum action.



75	2.5	T 101 BR	5	346079	312382	< 30	< 60	< 60	●						
----	-----	----------	---	---------------	--------	------	------	------	---	--	--	--	--	--	--



105	2.5	T101BR sp.	5	348072	313860	< 50	< 80	< 80	●						
-----	-----	------------	---	---------------	--------	------	------	------	---	--	--	--	--	--	--

Special application: laminated parquet flooring

Blade 373392 is ideally suited for cutting curves and irregular shapes. Use blade 373083 for straight cuts.



50	1.35	T 101 AO	5	373392	348879	< 20			●	< 15	●		●		
----	------	----------	---	---------------	--------	------	--	--	---	------	---	--	---	--	--



Bi-Metal	60	1.9	T 101 AIF	5	373083	346080	3-20		●	●		●			
-----------------	----	-----	-----------	---	---------------	--------	------	--	---	---	--	---	--	--	--

Jigsaw blades for metal



T-Shank Blades

Blade length (toothed) mm	Tooth pitch mm	Ref. No.	Qty.	Id. No. 4932	EAN Code 4002395	METAL	Cu/Ni/Ms/Zn	STAINLESS-INOX NIROSTA	ALU	P.V.C.	PERSPEX*	Depth of cut in mm
---------------------------	----------------	----------	------	--------------	------------------	-------	-------------	------------------------	-----	--------	----------	--------------------

Traditional blades

Blade reference 274652 is especially suited to cutting very thin sheet material because of its low 0.7 mm tooth pitch. For those professionals desiring extra lifetime and durability we recommend the use of Bi-Metal blades in conjunction with a suitable cooling lubricant, the blades lifetime is double that of non Bi-Metal blades.



55	0.7	T 118 G	5	274652	301621	0.5-2	0.5-2					
----	-----	---------	---	--------	--------	-------	-------	--	--	--	--	--



55	1.2	T 118 A	5	254063	301614	1.5-4	1.5-4					
			25	373486	349265							



Bi-Metal	55	1.2	T 118 AF	5	340011	304684	1.5-4	1.5-4	1.2-2			
-----------------	----	-----	----------	---	--------	--------	-------	-------	-------	--	--	--



75	1.2	T 118 A sp.	5	345826	313464	1.5-4	1.5-4					
----	-----	-------------	---	--------	--------	-------	-------	--	--	--	--	--



105	1	T 318 A	5	399307	359219	1-4	1-4	< 85				
-----	---	---------	---	--------	--------	-----	-----	------	--	--	--	--



55	2	T 118 B	5	254064	301591	3-6	3-6		3-10			
----	---	---------	---	--------	--------	-----	-----	--	------	--	--	--



Bi-Metal	55	2	T 118 BF	5	340012	304691	3-6	3-6	2-3	3-10	2-30	
-----------------	----	---	----------	---	--------	--------	-----	-----	-----	------	------	--



Bi-Metal	75	2.5	T 101 A sp.	5	274651	301577		2-10	< 45	3-10	2-20	
-----------------	----	-----	-------------	---	--------	--------	--	------	------	------	------	--

Universal application blades

These blades are suitable for cutting a wide variety of materials ranging from mild steel, aluminium, wood, with nails, plastics and sandwich composites. Blade 373086 with its extra length (155 mm) is suitable for cutting thick corrugated sandwich material.



Bi-Metal TWIN CUT	91	2.5/1.8	T 123 XF	5	430142	378036	2.5-10	3-10	< 50	4-10		
--------------------------	----	---------	----------	---	--------	--------	--------	------	------	------	--	--



Bi-Metal	105	1.2	T 318 AF	5	274654	301607	1.5-4	1.5-4	< 85			
-----------------	-----	-----	----------	---	--------	--------	-------	-------	------	--	--	--



Bi-Metal	105	2	T 318 BF	5	274653	301584	3-6	3-6	< 85	3-10	4-30	
-----------------	-----	---	----------	---	--------	--------	-----	-----	------	------	------	--



Bi-Metal	155	1.0	T 718 AF	5	373086	346097	1-4	1-4	< 125			
-----------------	-----	-----	----------	---	--------	--------	-----	-----	-------	--	--	--

Curve cutting blades

Especially narrower saw blade body allows one to cut tight curves in a range of metallic materials.



55	1.2	T 218 A	5	346082	312368	1.5-4	1.5-4					●
----	-----	---------	---	--------	--------	-------	-------	--	--	--	--	---



75	3	T 227 D	5	346081	312351	3.5-6	3.5-6		4-15	4-30		●
----	---	---------	---	--------	--------	-------	-------	--	------	------	--	---

Blade length (toothed) mm	Tooth pitch mm	Ref. No.	Qty.	Id. No. 4932	EAN Code 4002395						
						Depth of cut in mm					

Special application: aluminium

Most traditional blades are also capable of cutting aluminium however these two blades benefit from a larger tooth pitch and wider gullets for better material removal which is an advantage when cutting aluminium. When cutting curves or irregular shapes in aluminium we recommend the use of blade 346081.



75	3	T 127 D	5	274315	301560	3.5-6	3.5-6			4-15	4-30
----	---	---------	---	--------	--------	-------	-------	--	--	------	------

Special application: stainless steel

This blades teeth consist of a carbide tipped strip making it the most suitable and durable blade for steels with a high alloy content such as stainless steel. For best results work without pendulum action and use cutting oil as a lubricant.



50	1.1	T 118 AHM	2	373393	348886	1.5-3	1.5-3		1.5-3		
----	-----	-----------	---	--------	--------	-------	-------	--	-------	--	--



50	1.4	T 118 EHM	2	373394	348893	2-5	2-5		2-5		
----	-----	-----------	---	--------	--------	-----	-----	--	-----	--	--

Jigsaw blades for special materials

Blade length mm	Tooth pitch mm	Ref. No.	Qty.	Id. No. 4932	EAN Code 4002395						
						Depth of cut in mm					

Special applications: fibreglass/reinforced plastics/acrylic glass

Blade 373387 (pictured) has tungsten carbide teeth for longer lifetime in hard materials such as fibreglass.



Bi-Metal	75	2.5	T 101 A sp.	5	274651	301577	2-10			2-20	
-----------------	----	-----	-------------	---	--------	--------	------	--	--	------	--



	75	4.2	T 141 HM	1	399308	359226			5-20	5-20	5-50
--	----	-----	----------	---	--------	--------	--	--	------	------	------



	105	4.2	T 341 HM	1	373387	348824	< 60		5-20	5-20	
--	-----	-----	----------	---	--------	--------	------	--	------	------	--

Special application: abrasive material and cast iron



	54	Grain 30	T 130 Coarse	1	213231	301645		●	●	< 15	5-10 5-15
--	----	----------	--------------	---	--------	--------	--	---	---	------	-----------



	54	Grain 50	T 150 Fine	1	212232	301652		●	●	< 10	5-10 5-15
--	----	----------	------------	---	--------	--------	--	---	---	------	-----------

Blade length (toothed) mm	Tooth pitch mm	Ref. No.	Qty.	Id. No. 4932	EAN Code 4002395				
						Depth of cut in mm			

Special application: insulation material



155	wave knife	T 313 AW	5	430144	378050	●	●	●	●		
-----	------------	----------	---	--------	--------	---	---	---	---	--	--

Jigsaw blade sets - T-Shank reception

Description	Quantity	Id. No. 4932	EAN Code 4002395
5 piece set on blister card Includes one of each jigsaw blade 213116, 254061, 254063, 254064, 254071. Suitable for applications in wood and metal.	1	345825	314850



System accessories - Jigsaws

Description	M12 JS HD18 JS/JSB BST 18 X Li JS 120 X JSPE 135 TX STEP 1200 BX/X JSPE 90 X FSPE 110 X BSPE 110 QX STEP 800 X ST 800 XE V28 JSB	STEP 70 STEP 75 ST 700 E STEP 90 X STEP 100 X FSPE 100 XL BSPE 100 XL	Id. No. 4932	EAN Code 4002395
Gliding shoe	●		430356	380176
① for materials with delicate surfaces.		●	430834	384969
Anti-splintering device	●		357682	344147
② Set of three, prevents most splintering on the cutting edge.		●	367436	337644



Jigsaw blades - special reception



U-Shank Blades

Blade length (toothed) mm	Tooth pitch mm	Ref. No.	Qty.	Id. No. 4932	EAN Code 4002395	Wood	Aluminum	P.V.C.	Steel	Cast Iron	Concrete
Depth of cut in mm											
75	4	A 2202	5	354508	321070	5-60	●		●	●	
75	2.5	A5035/A5041	5	354506	321056	< 30	< 60	< 30	●		

Circular saw blades for wood

Circular saw blades for portable tools

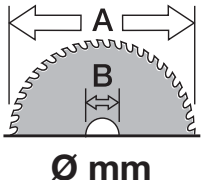

Ø mm

Ø mm A	Ø mm B	Number of teeth	Cutting width (kerf) mm	Solid wood	Chipboard	MDF / Fibreboard	Laminated chipboard	Block board	Plywood & OSB boards	Plastics	Plasterboard, breeze block, cemented plywood	Non FE metals, profiles, alu	Clean / Fine Cut	Id. No. 4932	EAN Code 4002395
160	20	12	2.4	✓	✓	✓					✓			327743	312962
		48	2.6	✓	✓	✓	✓	✓	✓		✓		✓	248233	307340
		42	2.8	✓	✓		✓	✓	✓	✓	✓	✓	✓	346511	318933
165	30	24	1.8	✓	✓	✓	✓	✓	✓	✓	✓			399909	365647
		36	2.6	✓	✓	✓	✓	✓	✓	✓	✓		✓	352133	367863
184	30	24	1.8	✓	✓	✓	✓	✓	✓	✓	✓			352327	369867
		48	1.8	✓	✓	✓	✓	✓	✓	✓	✓		✓	352328	369874
		54	2.0	✓	✓	✓	✓	✓	✓	✓	✓	✓	✓	352329	369881
190	30	16	2.4	✓	✓	✓					✓			256387	300709
		24	2.4	✓	✓	✓	✓	✓	✓	✓	✓			327969	319060
		48	2.8	✓	✓	✓	✓	✓	✓	✓	✓		✓	256388	300747
		54	2.8	✓	✓		✓	✓	✓	✓	✓	✓	✓	346512	318940
210	30	16	2.4	✓	✓	✓					✓			259182	300716
		48	2.8	✓	✓	✓	✓	✓	✓	✓	✓		✓	259136	300754
		54	2.8	✓	✓		✓	✓	✓	✓		✓	✓	346513	318957
230	30	48	3.0	✓	✓	✓	✓	✓	✓	✓			303099	305285	

Circular saw blades for cordless tools

140	20	18	1.3	✓	✓	✓	✓	✓	✓					430719	383801
165	20	24	2.6	✓	✓	✓	✓	✓	✓	✓	✓			352131	367849
		52	2.8	✓	✓	✓	✓	✓	✓	✓	✓		✓	352132	367856
165/6½"	15.87/5/8"	24	1.6	✓	✓	✓	✓	✓	✓					352313	369720
165/6½"	15.87/5/8"	40	1.6	✓	✓	✓	✓	✓	✓				✓	352314	369737
190	30	24	2.0	✓	✓	✓	✓	✓	✓					430430	380916

Circular saw blades for mitre saws

210	30	24	2.8	✓	✓	✓	✓	✓	✓					352135	367887
		48	2.6	✓	✓	✓	✓	✓	✓				✓	352136	367894
		54	2.6								✓	✓	✓	352137	367900
216	30	24	2.8	✓	✓	✓	✓	✓	✓					352839	374977
		48	2.4	✓	✓	✓	✓	✓	✓				✓	430720	383818
		48	2.8	✓	✓	✓	✓	✓	✓				✓	352840	374984
		80	2.8								✓	✓	✓	352841	374991
250	30	24	3.2	✓	✓	✓	✓	✓	✓					352138	367917
		48	3.2	✓	✓	✓	✓	✓	✓					352139	367924
		80	3.2	✓	✓	✓	✓	✓	✓				✓	361504	337088
		80	3.4								✓	✓	✓	352140	367931
305	30	60	3.2	✓	✓	✓	✓	✓	✓					352141	367948
		100	3.2	✓	✓	✓	✓	✓	✓				✓	352142	367955
		96	3.2								✓	✓	✓	352143	367962

Circular saw blades for metal

- ① Engineered tooth geometry for optimum performance.
- ② Top grade carbide and cermet tooth tips for superior lifetime.
- ③ Fully hardened and tensioned blade body for accurate cuts.
- ④ Deep gullets provide rapid and efficient chip removal.
- ⑤ Laser cut resin filled expansion slots for noise and vibration dampening (203 mm blade).

- Cuts clean: burr free edges reduce extra finishing processes.
- Cuts cool: the cut material can be handled immediately after cutting.
- Cuts fast: quicker than all other conventional cutting methods.
- Cost cutter: less expensive per cut than abrasive discs.
- Reduced noise.
- Reduced vibration.
- Total safety: no sparks, no coolants, cool to touch.



Material guide

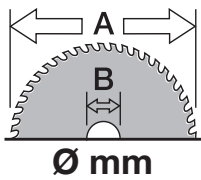

Ø A	Ø B	Number of teeth	Cutting width (kerf) mm	Material wall thickness	Material															Id. No.	UPC Code
					Mild steel	Thin steel plate/sheet < 2.5 mm	Corrugated steel panels < 2.5 mm	Steel tube	Steel pipe	Angle iron	Steel channel	Stainless steel plate/sheet	Cast iron	Copper	Aluminium	Rebar	Sandwich material (steel/foam panels)				
135	20	30	1.6	1-2.5 mm	✓	✓	✓	✓	✓	✓	✓	◆	×	×	×	×	✓	48404070	45242233786		
		50	1.6		×	×	×	×	×	×	×	×	×	✓	✓	×	◆	48404075	45242233793		
165 (6 1/2)	15.87 (5/8)	48	1.6	1-2.5 mm	✓	✓	✓	✓	✓	✓	✓	×	×	×	×	×	✓	48404015	45242134298		
174	20	36	1.65	> 2.5 mm	✓	×	×	✓	✓	✓	✓	×	×	×	×	×	×	48404016	45242134120		
		50	1.65	1-2.5 mm	✓	✓	✓	✓	✓	✓	✓	◆	×	×	×	×	✓	48404017	45242151738		
203 (8)	15.87 (5/8)	42	1.8	> 2.5 mm	✓	×	×	✓	✓	✓	✓	×	×	×	×	×	×	48404515	45242134465		
		50	1.8	1-2.5 mm	✓	✓	✓	✓	✓	✓	✓	◆	×	×	×	×	✓	48404520	45242134472		

✓ Most suitable. Recommended for these materials. ✗ Not suitable. Not recommended for these materials.
 ◆ Suitable. Recommended for intermittent use in these materials.
 Very good cutting characteristics, but greatly reduced lifetime of the blade.

Optimising Blade Life

1. Clamp the workpiece securely to avoid vibration.
2. Do NOT stack or bundle cutting material. The gaps between layers allow for more opportunities to chip the teeth. The life of the blade is severely affected by this type of cutting.
3. Lower the blade to its maximum cutting capacity and allow the tool to come to full speed before applying the blade to the material.
4. Do NOT force the saw blade into the material. Start gently, then gradually apply enough pressure to avoid sparks.
5. Optimal cutting speed and pressure will produce little or no sparks. Sparking creates heat build up which shortens saw blade life.
6. Keep the cut straight. If following a cut line and you wander off the line, getting back on line may cause side loading of the blade and break teeth. Use an edge guide whenever possible.
7. Do NOT apply side pressure on the blade as this will cause chipping of the teeth.
8. Periodically allow the tool to run free of the cutting material to cool the blade and tool especially when making long cuts or cuts in thick material.

System accessories - Circular saws

Description	HK 46 N	K 55/S 66/S CS 55	PCS 55	SCS 65 Q	CS 75 HKS 75 HK 75 A	HKS 85	PMS 18	Id. No. 4932	UPC/EAN Code 4002395
Clean Line system									
① with bag holder ② and 3 paper bags.		●		●				346123*	13266
② Cloth bag requires bag holder 346123.		●		●				346182*	13273
Dust absorption connector			●					369282	38412
Extraction hose								259301*	04158
③ Ø 35 mm/4 m		●			●	●		330552	12719
④ Ø 26 mm/4 m	●		●					278824	08286
Spanner for removing saw blade	●	●	●	●	●	●		371469	42181
Parallel guide/fence		●			●		●	276288	08217
Transport case - plastic				●				49221001	45242180417
DEK26					●			49224146	45242181896
⑤ Dust extraction hood for MS 216 Mitre Saw				●				201672001	840519
								430005	376667



Planer blades

Description	82 mm	102 mm	Id. No. 4932	EAN Code 4002395
	H 500/750 PR 1.6-82 PR 3-82	HB 750 HBE 800 PR 2.5-102		
Tungsten carbide reversible blades	●		273484	300150
Two reversible blades, suitable for soft and hard woods.		●	316243	300167



System accessories - Planers

Description	All planers 82/102 mm	Quantity	Id. No. 4932	EAN Code 4002395
Hose connections				
Suction sleeve for suction hoses 330552.	●	1	316270	302017
Parallel guide	●	1	274071	300358
Folding rebate depth gauge				
For all planers except H 500/PR 1.6-82 models.	●	1	274069	300129
Clamp (single piece)				
① For planer/thicknesser bench mounting kit. 2 pieces required.	●	1	367730	338566



* while stocks last

Band saw blades

Choosing the right tooth geometry

10 Tpi Tooth pitch 2.5 mm	10/14 Tpi Tooth pitch 2.5/1.8 mm	14 Tpi Tooth pitch 1.8 mm	14/18 Tpi Tooth pitch 1.8/1.4 mm	18 Tpi Tooth pitch 1.4 mm	25 Tpi Tooth pitch 1 mm
FOR CUTTING STOCK 8 to 13 mm	FOR CUTTING STOCK 5 to 13 mm	FOR CUTTING STOCK 5 to 8 mm	FOR CUTTING STOCK 4 to 8 mm	FOR CUTTING STOCK 4 to 5 mm	FOR CUTTING STOCK < 4 mm

Bi-Metal blades with matrix II high speed steel teeth with 8% cobalt outlast conventional blades up to 3 times, requiring fewer blade changes.

Extremely hard and uniform tooth point is electron beam welded to a tough durable backing with high flex life for faster cutting, and longer blade life.

High speed cutting of aluminium, angle iron, bronze, brass, copper, galvanized pipe, mild steel.

Tougher steels including stainless, chrome, tungsten steel plus other problem materials at slow speed.

Blade length 1139.83 mm (corded & M18 FUEL[™])

Material wall thickness mm	Tooth pitch mm	Teeth per inch	Qty.	Id. No.	UPC Code 45242
≥ 8	2.5	10	3	48390501	132096
5 to 8	1.8	14	3	48390511	132164
4 to 5	1.4	18	3	48390521	132263
≤ 4	1.0	25	3	48390531	132362

Blade length 898.52 mm (M18)

Material wall thickness mm	Tooth pitch mm	Teeth per inch	Qty.	Id. No.	UPC Code 45242
5 to 8	1.8	14	3	48390519	201594
4 to 5	1.4	18	3	48390529	201747
≤ 4	1.0	25	3	48390539	201815

Blade length 687.57 mm (M12)

Material wall thickness mm	Tooth pitch mm	Teeth per inch	Qty.	Id. No.	UPC Code 45242
2.5 to 8	1.4	18	3	48390572	272341

Bi-Metal multi-pitch blades

Designed with varying set angles and gullet depths to break up the harmonic vibrations generated in cutting, resulting in smoother, quieter cutting and longer blade life.

Designed for interrupted cutting applications (tubing, structurals, etc.).

Also production cutting of solids in variety of sizes or shapes.

Blade length 1139.83 mm

Material wall thickness mm	Tooth pitch mm	Teeth per inch	Qty.	Id. No.	UPC Code 45242
5 to 13	2.5/1.8	10/14	3	48390551	132461
4 to 8	1.8/1.4	14/18	3	48390561	132560

Expander heads

Expander heads	Pipe Ø mm	Pipe wall thickness mm	Pipe pressure bar	Tool suitability	Id. No. 4932	EAN Code 4002395
PXPH9.9-144/8	9.9	1.1	4/8	M12 M18	430102	377633
PXPH12I-14	12	1.7/1.8/2.0	6-10	M12 M18	352716	373741
PXPH15N-14	14/15	2.5	6-10	M12 M18	352727	373857
PXPH16I-1406	16	1.5/1.8	6	M12 M18	430103	377640
PXPH16I-1410	16	1.8/2.0/2.2	10	M12 M18	352717	373758
PXPH18N-14	17/18	2.5	6-10	M12 M18	352728	373864
PXPH20I-1406	20	1.9/2.0/2.3	6, (8 bar for Ø 2.3 mm)	M12 M18	352718	373765
PXPH20I-1410	20	2.8	10	M12 M18	352719	373772
PXPH20I-2506	20	1.9/2.0/2.3	6, (8 bar for Ø 2.3 mm)	M18	352733	373918
PXPH20I-2510	20	2.8	10	M18	352748	374069
PXPH22N-14	22	3	6-10	M12 M18	352729	373871
PXPH25I-1406	25	2.3	6	M12 M18	352720	373789
PXPH25I-1410	25	3.5	10	M12 M18	352721	373796
PXPH25I-2506	25	2.3	6	M18	352722	373802
PXPH25I-2510	25	3.5	10	M18	352749	374076
PXPH28N-14	28	4	6-10	M12 M18	352730	373888
PXPH32I-1406	32	2.9	6	M12 M18	352723	373819
PXPH32I-25	32	2.9/4.4	6-10	M18	352724	373826
PXPH40I-2506	40	3.7	6	M18	352725	373833
Grease Tube contents 50 g. For lubrication of cone and expander heads.					352726	373840



System accessories - Routers

Description	OFE 710 OFE 630 OFS 450	OFSE 1000 OFSE 850 OFS 720 OFE 650	Quantity	Id. No. 4932	EAN Code 4002395
Precision collet for router High rotation accuracy.					
Ø 3 mm	●		1	308974	309092
Ø 6.35 mm (¼")	●		1	313194	302857
① Ø 6 mm	●		1	313192	302833
Ø 6 mm		●	1	256210	306237
Ø 6.35 mm (¼")		●	1	249981	307517
Ø 8 mm		●	1	256303	302703
Ø 8 mm	●		1	313190	302840
Screw clamp (single piece) for stationary use of routers when used with flexible shaft (2 pieces required).	●	●	1	367730	338566

①



②



System accessories - Biscuit jointers

Description	PJ 710 LF 650	Quantity	Id. No. 4932	EAN Code 4002395
6 tooth cutter 100x22.2 mm	●	1	361072	326679
Frame holder for dust bag 4931443873	●	1	4931442872	247899
Dust bag – paper (requires 4931442872)	●	5	4931442873	247882
Two hole spanner	●	1	345712	305551



System accessories - Straight die grinders

Description	DG 14-50 Q	GS 500 E GSL 600 E DGL 34 DGL 30 E DG 30 E PSG 12 HD 28 SG V28 SG PSG 14.4 PP HD18 SG	DG 7 E	Quantity	Id. No. 4932	UPC/EAN Code 4002395
Collet Ø	3 mm	●		1	308974	309092
	6 mm	●		1	313192	302833
	6 mm		●	1	4931391453	734818
	8 mm	●		1	313190	302840
	8 mm		●	1	4931391452	734801
	6.35 mm (1/4")	●		1	313194	302857
6 mm collet		●		1	48660978	45242155620
8 mm collet		●		1	48660976*	45242156269



System accessories - Plate shears

Description	SMC 1.2 Q	PPS 12 (cordless)	KS 2.5 S 2.5	Quantity	Id. No. 4932	UPC/EAN Code 4002395
Piston blade four sided blade		●		1	308837	311583
Cutting table blade four sided blade		●	●	1	430171	378326
Centre blade	●			1	48440150	45242140701
Left blade	●			1	48440160	45242140756
Right blade	●			1	48440170	45242140800
Socket wrench 5/32"	●			1	49960070	45242221554
Replacement shear head assembly	●			1	48080500*	45242089253



System accessories - Nibblers

Description	KN 2 N 2	PN 14.4 PN 12 (cordless)	Quantity	Id. No. 4932	EAN Code 4002395
Punch	●	●	1	430172	378333
Die	●	●	1	279565	308521
Special die Especially designed for cutting corrugated curved steel; max. cutting capacity 1.5 mm (not for trapezoidal steel sheet).	●	●	1	279498	308514



System accessories - Stone saw

Standard blade set

Suitable for brick, breeze blocks and lightweight aggregate building blocks upto a compressive strength of 40 N/mm².

Not suitable for cutting concrete, building blocks or hard bricks (engineering bricks) that exceed a compressive strength of 40 N/mm².

Description	Id. No. 4932	EAN Code 4002395
Left and right blade / 42 TCT teeth per blade	392290*	343379

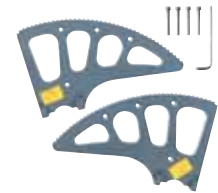

System accessories - Pipe cutter/Cable cutter

Description	Quantity	Id. No. 4932	UPC/EAN Code 4002395
Pipe cutter wheels			
① Pack of 2. Suitable for copper pipe. Not suitable for plastic or stainless steel pipe.	1	48380010	45242159710
② Cable cutter blade	1	430070	377312



System accessories - Electrical T&M

Description	Quantity	Id. No.	EAN Code 4002395
Electrical test probes			
① (max. 1000 Volts/10 Amps) heads 125 mm long.	1	49771004	806294
Electrical alligator clips			
② (max. 1000 Volts/10 Amps)	1	49771005	806287



* while stocks last

System accessories - Inspection cameras

All extension cables are water splash and dust proof.
Extensions are attached between the base camera unit and standard supplied camera cable.

Description	Cable length	Ø Cable	C12 IC	C12 AVD	C12 AVA	Id. No.	UPC Code 45242
Cable extension Up to a maximum of 3 extensions can be fixed together.	90 cm	17 mm	✓			48530110	157747
Cable extension Up to a maximum of 5 extensions can be fixed together.	90 cm	17 mm		✓	✓	48530141	216529
Cable extension Up to a maximum of 2 extensions can be fixed together.	240 cm	17 mm	✓	✓	✓	48530140	195787
Replacement digital camera cable	90 cm	17 mm	✓			4931411079	4002395907007
Replacement digital camera cable	90 cm	17 mm		✓	✓	4931419516	4002395828227
Replacement analog camera cable	90 cm	9,5 mm		✓	✓	4931419517	4002395828234



System accessories - M12™ Heated jacket

- **M18™ USB Power Source – M18™ USB PS HJ**
 - Powers the jacket on M18™ battery packs.
 - USB charging port for MP3 player, mobile phone, digital camera, GPS.
- **12 V Car Plug – 12 V CP HJ**
 - Powers the jacket on any 12 V cigarette style outlet.

①



②



Description	Quantity	Id. No. 4932	EAN Code 4002395
① M18™ USB Power Source (M18™ USB PS HJ)	1	430084	377459
② 12 V Car Plug (12 V CP HJ)	1	430085	377466

Transport cases

Tool cases (plastic)	Id. No. 4932	EAN Code 4002395
① Cases supplied with latches and foam insert. Size 1 (LxWxH) 475x358x132 mm	378986	349401
② Size 2 (LxWxH) 475x358x192 mm	383162	349463
③ Spare latches (2pc)	373252	347247

①



②











③



Product category	Fits to	Metal/Plastic	Id. No.	UPC/EAN Code 4002395
Hammers	K 900, K 950	M	4931375502	752881
Sabresaws/SAWZALLS®	All SAWZALLS® Universal case	P	48556510	45242148424
Wall chasers	WCE 30, MFE 1500 WCS 45, MF 1900	M	4932383357	357390

Press jaws

Jaw profile	Fits to following pipe systems suppliers	Nominal size	Tool suitability	Jaw model description	Id. No. 4932	EAN Code 4002395		
M	Geberit: Mapress VSH: X-Press Eurotubi Raccorderie Metallique Rubinetteria Bresciane Sanha: Nirosoan Pegler Yorkshire	M12	M12	J12-M12	430243	379040	 Jaw M profile	
		M12	M18	J18-M12	430244	379057		
		M15	M12	J12-M15	430245	379064		
		M15	M18	J18-M15	430246	379071		
		M18	M12	J12-M18	430247	379088		
		M18	M18	J18-M18	430248	379095		
		M22	M12	J12-M22	430249	379101		
		M22	M18	J18-M22	430250	379118		
		M28	M12	J12-M28	430251	379125		
		M28	M18	J18-M28	430252	379132		
		M35	M12	J12-M35	430253	379149		
		M35	M18	J18-M35	430254	379156		
		M42	M18	RJ18-M42 (requires ring jaw adaptor RJA-1)	430255	379163		 Ring jaw M profile
		M54	M18	RJ18-M54 (requires ring jaw adaptor RJA-1)	430256	379170		
V	Viega Comap IBP Sanha: Nirosoan	V12	M12	J12-V12	430260	379217	 Jaw V profile	
		V12	M18	J18-V12	430261	379224		
		V15	M12	J12-V15	430262	379231		
		V15	M18	J18-V15	430263	379248		
		V18	M12	J12-V18	430264	379255		
		V18	M18	J18-V18	430265	379262		
		V22	M12	J12-V22	430266	379279		
		V22	M18	J18-V22	430267	379286		
		V28	M12	J12-V28	430268	379293		
		V28	M18	J18-V28	430269	379309		
		V35	M12	J12-V35	430270	379316		
		V35	M18	J18-V35	430271	379323		
		V42	M18	RJ18-V42 (requires ring jaw adaptor RJA-1)	430272	379330		 Ring jaw V profile
		V54	M18	RJ18-V54 (requires ring jaw adaptor RJA-1)	430273	379347		
TH	ALB Comap Fränkische Henco (TH14 - TH25 only) IPA Sanha Tiemme	TH14	M12	J12-TH14	430274	379354	 Jaw TH profile	
		TH14	M18	J18-TH14	430275	379361		
		TH16	M12	J12-TH16	430276	379378		
		TH16	M18	J18-TH16	430277	379385		
		TH18	M12	J12-TH18	430278	379392		
		TH18	M18	J18-TH18	430279	379408		
		TH20	M12	J12-TH20	430280	379415		
		TH20	M18	J18-TH20	430281	379422		
		TH25	M12	J12-TH25	430282	379439		
		TH25	M18	J18-TH25	430355	380169		
		TH26	M12	J12-TH26	430283	379446		
		TH26	M18	J18-TH26	430284	379453		
		TH32	M12	J12-TH32	430285	379460		
		TH32	M18	J18-TH32	430286	379477		
		TH40	M12	J12-TH40	430287	379484		
		TH40	M18	RJ18-TH40 (requires ring jaw adaptor RJA-1)	430288	379491		 Ring jaw TH profile
		TH50	M18	RJ18-TH50 (requires ring jaw adaptor RJA-1)	430289	379507		
		TH63	M18	RJ18-TH63 (requires ring jaw adaptor RJA-1)	430290	379514		
U	ALB Uponor: Unipipe, Airpipe Kann: Kann-therm Wavin: Press-Systeme Fränkische: Alpex F50 Profi DW Verbundrohr: Multitubo IBP: >B< Flex KE Kelit: Kelit Kelox Jupiter: Heizsystem	U14	M12	J12-U14	430291	379521	 Jaw U profile	
		U14	M18	J18-U14	430292	379538		
		U16	M12	J12-U16	430293	379545		
		U16	M18	J18-U16	430294	379552		
		U18	M12	J12-U18	430295	379569		
		U18	M18	J18-U18	430296	379576		
		U20	M12	J12-U20	430297	379583		
		U20	M18	J18-U20	430298	379590		
		U25	M12	J12-U25	430299	379606		
		U25	M18	J18-U25	430300	379613		
		U32	M12	J12-U32	430301	379620		
		U32	M18	J18-U32	430302	379637		
		U40	M12	J12-U40	430303	379644		
		U40	M18	RJ18-U40 (requires ring jaw adaptor RJA-1)	430304	379651		 Ring jaw U profile
		U50	M18	RJ18-U50 (requires ring jaw adaptor RJA-1)	430305	379668		
		U63	M18	RJ18-U63 (requires ring jaw adaptor RJA-1)	430306	379675		
① Ring jaw adaptor				RJA-1	430307	379682	 Ring jaw adaptor	

System accessories - Caulk and adhesive guns

Description	PCG 14/300 PCG 14/600	C18 PCG	C12 PCG	Id. No.	UPC Code 45242
310 ml standard carriage Accepts all standard 250 ml and 310 ml tubes/cartridges. Requires plunger rod 49520600.	✓			48081075	087938
310 ml standard carriage Accepts all standard 250 ml and 310 ml tubes/cartridges. Includes plunger rod assembly 4932352937, piston for carriage assemblies and a feed screw 44700330.		✓		48081076	263127
310 ml standard carriage Accepts all standard 250 ml and 310 ml tubes/cartridges. Includes plunger rod assembly 4932430099, piston for carriage assemblies and a feed screw 44700330.			✓	48080900	286355
310 ml Aluminium sausage tube barrel Accepts standard 310 ml "sausage style" material packs and 380 ml cartridges. Requires plunger rod 49520660.	✓			48081085	089246
400 ml Aluminium sausage tube barrel Accepts standard 400 ml "sausage style" material packs (includes 2 end cups). Requires plunger rod 48091090 and piston 44700375.		✓	✓	4932352844	4002395375028
600 ml Aluminium sausage tube barrel Accepts standard 600 ml "sausage style" material packs. Requires plunger rod 49520660.	✓			48081090	087952
600 ml Aluminium sausage tube barrel Accepts standard 600 ml "sausage style" material packs (includes 2 end cups). Requires plunger rod 48091091 and piston 44700375.		✓	✓	4932352845	4002395375035
400 ml Transparent sausage tube barrel Accepts standard 400 ml "sausage style" material packs (includes 2 end cups). Requires plunger rod 48091090 and piston 44700375.		✓	✓	4932352842	4002395375004
600 ml Transparent sausage tube barrel Accepts standard 600 ml "sausage style" material packs (includes 2 end cups). Requires plunger rod 48091091 and piston 44700375.		✓	✓	4932352843	4002395375011
Plunger rod assembly for 310 ml carriage For use with: 48081076 310 ml standard carriage.		✓		4932352937	4002395375950
Plunger rod assembly for 310 ml carriage For use with: 48080900 310 ml standard carriage.			✓	4932430099	4002395377602
Plunger rod Short (340 mm long) For use with 48081075 carriage and 48081085 "sausage style" barrel.	✓			49520600	190201
Plunger rod assembly for 400 ml sausage tube barrel For use with: 4932352844 400 ml aluminium sausage tube barrel 4932352842 400 ml transparent sausage tube barrel.		✓		48091090	263158
Plunger rod assembly for 400 ml sausage tube barrel For use with: 4932352844 400 ml aluminium sausage tube barrel 4932352842 400 ml transparent sausage tube barrel.			✓	4932430100	4002395377619
Plunger rod assembly Long (480 mm long) For use with 48081090.	✓			49520660	190164
Plunger rod assembly for 600 ml sausage tube barrel For use with: 4932352845 600 ml aluminium sausage tube barrel 4932352843 600 ml transparent sausage tube barrel.		✓		48091091	263165
Plunger rod assembly for 600 ml sausage tube barrel For use with: 4932352845 600 ml aluminium sausage tube barrel 4932352843 600 ml transparent sausage tube barrel.			✓	4932430101	4002395377626
Piston for carriage assemblies (includes feed screw). For use with 48081076 310 ml standard carriage.		✓	✓	44700330	260928
Piston for sausage tube barrels (includes feed screw). For use with: 4932352844 400 ml aluminium sausage tube barrel 4932352845 600 ml aluminium sausage tube barrel 4932352842 400 ml transparent sausage tube barrel 4932352843 600 ml transparent sausage tube barrel.		✓	✓	44700375	277438
Replacement nozzles (1 piece).	✓	✓	✓	45760525	-

System accessories for dust absorption systems

Description		AP 250 ECP	AP 300 ECP	AS 250 ECP / AS 2-250 ECP	AS 300 ECP	AS 500 ECP	AS 300 EMAC / AS 300 ELAC	NT 900	NT 1500 A	NT 1200	WDC 1400 A	RSE	AS 1	AS 2 C	AS 3 W	RSE 1400	ASE 1400 / ASM 1400	Quantity	Id. No. 4932	EAN Code 4002395	
System Ø 26 mm	Extension hose 4 m long								•	•	•	•	•	•	•			1	278824*	308286	
	Extension hose. Antistatic, 4 m long, 36 mm diameter with tool adaptor.		•		•	•	•												1	352311	369706
System Ø 35 mm	Extension hose. 3.5 m long, 32 mm diameter with tool adaptor.	•	•	•															1	352312	369713
	Adapter Allows direct connection to 35 mm extensions.											•	•	•					1	430833	384952
	Universal reduction sleeve 35/33/27 mm										•	•	•	•	•	•	•	•	1	369282	338412
	Suction tube, 50 cm, plastic								•	•		•	•	•		•	•	•	1	346620	319503
	Carpet nozzle Can be switched for smooth floors/carpets.								•	•		•	•	•	•	•	•	•	1	272584	303243
	Gap nozzle, narrow								•	•		•	•	•	•	•	•	•	1	276048	303250
	Extension hose, 4 m long											•	•	•	•	•	•	•	1	330552*	312719
	Extension hose, 5 m long																•	•	1	373626	351534
	Extension hose, 3 m long							•	•	•									1	300171	308576
	Gap nozzle, wide								•	•		•	•	•		•	•	•	1	316070	310449
System Ø 50 mm	Suction tube, without hooks											•	•	•		•	•	1	316069	310432	
	Reduction sleeve. Reduces the hose system from 50 mm to 35 mm.								•	•		•	•	•		•	•	1	316074	310456	
	Filter bags, 5 pcs. (5x fleece filter bags)	•		•															1	352306	369652
	Filter bags: 5x fleece filter bags, 30 l		•		•														1	352307	369669
	Filter bags: 5x fleece filter bags, 50 l					•													1	352308	369676
	Disposable bags: 5x plastic bags, 30 l	•	•	•	•	•													1	352309	369683
	Disposable bags: 5x plastic bags, 50 l					•													1	352310	369690
	Filter bag, paper, 5-pack, 10 l												• ¹⁾	•					1	346619	319428
	Filter bag adapter for RSE+AS2C, light-duty												•	•	•	•			1	346812	319534
	Filter bag, paper, 3-pack, 18 l, light-duty								•										1	340125	305445
Filter bags	Filter bag, paper, 3-pack, 18 l, heavy-duty							•										1	373669	351824	
	Filter bag, paper, 5-pack, 25 l, heavy-duty													•	•			1	346585	319442	
	Filter bag, fleece, 5-pack, 25 l, heavy-duty															•		1	373852	352821	
	Filter bag, fleece, 5-pack, 50 l, heavy-duty																•		1	373621	351503
	Filter bag, paper, 3-pack							•											1	316045	302598
	Filter bag, cloth							•											1	276019	303267
	Filter bag, plastic, 3-pack, 25 l. Suitable for fine concrete dust. Conforms to dust classification M&H (EN 60335-2-69) Only suitable for ASM 1400.																•		1	399502	361595
	Filter cartridge	•		•															1	352303	369621
	Filter cartridge		•		•	•													1	352304	369638
	Filter cartridge					•													1	352305	369645
Filter cartridge, 3600 cm ² , BIA usage Cat. C												•	•					1	346587	319466	
SR filter cartridge, self cleaning 6800 cm ² , BIA usage Cat. C												•		•				1	346338	313778	
Filter cartridge, 7000 cm ² , BIA usage Cat. C															•			1	346588	319473	
Filter cartridge, 7200 cm ²												•						1	327205	303885	
Filter cartridge								•	•									1	340124	305452	
Flat folded polyester filter cartridge, 2 pcs.																•	•	1	373623	351510	

¹⁾ In combination 346812 bag adapter and filter cartridge 346587.

* while stocks last

Chargers

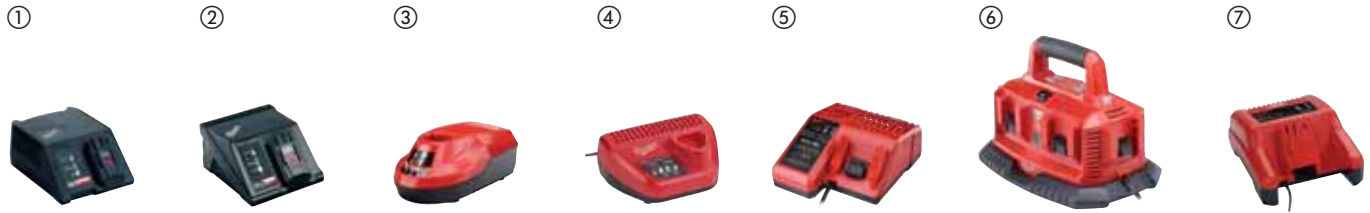

Description	System	Charging range	Charging time	For battery type			Id. No. 4932	EAN Code 4002395
				NiCd	NiMH	Li-Ion		
① TCA 7224 MB	PBS 3000	7.2–24 V	12 min.	●	●	–	399035	356393
② RCA 7224 MB	PBS 3000	7.2–24 V	47 min.	●	●	–	386670	352388
③ M4 C	M4	4 V	30 min.	–	–	●	352958	376162
④ C12 C	M12	12 V	40/80 min.	–	–	●	352000	366606
⑤ M12-18C	M12, M18, M14	12–18 V	40/80 min.	–	–	●	352959	376179
⑥ M1418 C6	M14, M18	14.4–18 V	40/80 min.	–	–	●	430086	377473
⑦ M28 C	M28	28 V	60/90 min.	–	–	●	352524	371822

Lamps & bulbs



Description	Voltage V	Battery type	System	Battery compatibility	Bulb type	Id. No. 4932	EAN Code 4002395
① M12 TLED-0	12	Li-Ion	M12	All Milwaukee [®] M12 [™] batteries	LED	430360	380213
② M12 SL-0	12	Li-Ion	M12	All Milwaukee [®] M12 [™] batteries	LED	430178	378395
③ M12 LL-0	12	Li-Ion	M12	All Milwaukee [®] M12 [™] batteries	LED	430562	382231
④ M18 TLED-0	18	Li-Ion	M18	All Milwaukee [®] M18 [™] batteries	LED	430361	380220
⑤ M18 AL-0	18	Li-Ion	M18	All Milwaukee [®] M18 [™] batteries	LED	430392	380534
⑥ M18 LL-0	18	Li-Ion	M18	All Milwaukee [®] M18 [™] batteries	LED	430563	382248
⑦ M18 IL-0	18	Li-Ion	M18	All Milwaukee [®] M18 [™] batteries	LED	430564	382255
⑧ M28 WL-0	28	Li-Ion	M28	All Milwaukee [®] M28 [™] batteries	Xeon	352526	371846
⑨ M28 WL LED-0	28	Li-Ion	M28	All Milwaukee [®] M28 [™] batteries	LED	352527	371853

Batteries



Description	System	Battery type	Voltage V	Battery pack capacity Ah	Id. No. 4932	EAN Code 4002395
① M4 B2	M4	Li-Ion	4	2.0	430098	377596
② M12 B2	M12	Li-Ion	12	2.0	430064	377251
③ M12 B4	M12	Li-Ion	12	4.0	430065	377268
④ M14 B	M14	Li-Ion	14	1.5	352665	373239
⑤ M14 B4	M14	Li-Ion	14	4.0	430323	379842
⑥ M18 B2	M18	Li-Ion	18	2.0	430062	377237
⑦ M18 B4	M18	Li-Ion	18	4.0	430063	377244
⑧ M18 B5	M18	Li-Ion	18	5.0	430483	381449
⑨ M28 BX	M28	Li-Ion	28	3.0	352732	373901
⑩ M28 B5	M28	Li-Ion	28	5.0	430484	381456



Description	System	Battery type	Voltage V	Battery pack capacity Ah	Id. No. 4932	EAN Code 4002395
① B 12	PBS 3000	NiCd	12	1.4	373527	350292
② BXS 12	PBS 3000	NiCd	12	2.0	373529	350315
③ BXL 12	PBS 3000	NiCd	12	2.4	373530	350322
④ MXL 12	PBS 3000	NiMH	12	3.0	399311	360307
⑤ BXS 14.4	PBS 3000	NiCd	14.4	2.0	373540	350445
⑥ BXL 14.4	PBS 3000	NiCd	14.4	2.4	373541	350452
⑦ MXL 14.4	PBS 3000	NiMH	14.4	3.0	399413	360321
⑧ BXL 24	PBS 3000	NiCd	24	2.4	373560	350636

MAGSWITCH™

Never before has a super-strong permanent magnet been so easy to control.

Milwaukee® Magswitch™ has created a powerful magnetic device that can be turned on and off with a simple turn of a knob.

No batteries! No electricity!

Advantages:

- Saves time and money
- Faster/easier grounding
- Replaces clamps
- Fast, precise positioning and workholding
- Welding angles that stay clean
- Super strong, controllable hold

Magswitch™ MagSquares

Hold just about anything, just about anywhere.

Milwaukee® MagSquares provide a new level of fast and easy multiplane workholding when positioning steel. MagSquares exert a powerful magnetic field with a simple 180° rotation of the knob.

- Holds metal on multiple sides for welding ease.
- Attaches to flat and round surfaces.
- Machined for precise 90° angles.
- Includes pre-tapped holes on all sides to mount accessories or make jigs/templates.

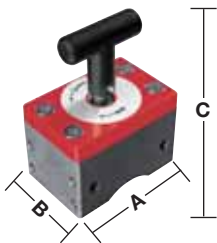

Description	A mm	B mm	C mm	Breakaway force kg	Breakaway force N	Pre-tapped hole size	Id. No. 4932	EAN Code 4002395
Mag-SQ 68	40	40	70	68	666	M5x6 mm	352566*	372249
Mag-SQ 272	75	50	110	272	2665	M6x10 mm	352567*	372256

Magswitch™ 90° angles

90° welding angles have never been this easy to use.

Milwaukee® Magswitch™ 90° Welding Angles provide both inside and outside holding. The easy on/off of Magswitch™ eliminates the need to pry off the angle and allows you to keep the angle free of debris.

- Precise positioning, holds flat and pipe material.
- Additional MagSquares can be added for greater strength.
- Available in 2 sizes (each angle has 2 magnets).

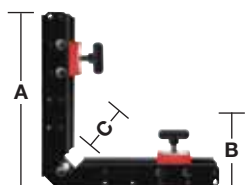

Description	A mm	B mm	C mm	Breakaway force kg	Breakaway force N	Id. No. 4932	EAN Code 4002395
Mag-Angle 68	205	33	60	68	666	352569*	372270
Mag-Angle 272	285	51	105	272	2665	352570*	372287

Magswitch™ boomerangles

Welding boomerangles versatile and powerful.

Milwaukee® Magswitch™ Boomerangles are extremely versatile, the magnets can pivot allowing holding possibilities at different angles. The easy on/off of Magswitch™ eliminates the need to pry off the angle.

- Virtually fully adjustable. Each MagSquare pivots to the desired angle.
- Holds flat and pipe material.
- Available in 2 sizes (each angle has 2 magnets).



Description	A mm	B mm	C mm	Break-away force kg	Break-away force N	Id. No. 4932	EAN Code 4002395
Mag-Boomerangle 68	195	69	137	68	666	352571*	372294
Mag-Boomerangle 272	254	108	164	272	2665	352572*	372300

Magswitch™ hanging hooks

It's like having an extra hand.

Milwaukee® Magswitch™ Hanging Hooks let you hang tools, lights, support wires, air hoses, welding lines and more, quickly and easily. Using the hanging hooks, everything you need can be within reach.

- Perfect for temporary holding of lines, hoses, tools or loose nuts and bolts.
- Perfect for use around the job site or shop.
- Precise positioning, attaches to flat or round surfaces.
- Quickly secures and holds just about anything, anywhere.



Description	A mm	B mm	Working load kg	Id. No. 4932	EAN Code 4002395
Mag-H 18	70	105	18	352577*	372355

* while stocks last



TITANIUM TOOLS

Since 1849 Stiletto[®] Tools has been renowned worldwide for premium quality professional tools. Stiletto was the first company to introduce Titanium hammers, the product line of today combines the latest technology in materials, design and balance to give professional users extra power, effortless striking and overall higher productivity.

- Hitting power:** Titanium delivers 97% of the swing energy to the nail.
- Durability:** More flexible and fracture resistant than steel. Accepts harder impacts without distorting the overall shape of the hammer. One-piece design – strength built in from the head right through to the handle providing for best stability.
- Rust resistant:** Hammers are predominantly used outdoors. Titanium is 100% corrosion resistant.
- Less fatigue:** Titanium weighs 45% less than steel. Titanium has the highest strength to weight ratio of any metal. Less weight allows one to swing the hammer faster creating greater head speed resulting in more power. Titanium hammers drive 30% more nails with the same effort. Light hammer can be swung faster, it puts less strain on the body without compromising work efficiency.
- Less arm pain and vibration:** Titanium provides 10 times greater dampening of harmful recoil shock vibrations compared to steel. Excessive hammer use can cause long term damage to the arm.
- More productivity:** Drives up to 30% more nails with the same effort.

100% Titanium TiBone[™] hammers

- Strongest handle:** All titanium one piece frame. 200% stronger than wood.
- Longer lifetime:** Replaceable faces instead of replacing the complete hammer.
- Pulls nails easier:** Patented 180° side nail puller.
- Magnetic nail starter:** Helps to start nails in difficult to reach places.

Model No.	Weight oz. g	Re- placeable face	Face	Length Inch mm	Id. No. 4932	EAN Code 4002395
① TB15MC + TBM-SR	15 425	✓	Supplied with milled and smooth face	18" 457	352578	372362
② TBM14RMC + TBM-SR	14 397	✓	Supplied with milled and smooth face	15 1/4" 388	352579	372379



Titanium hammers with wood handles

Traditional hickory wood handle: Curved axe type grip for comfortable handling.

Magnetic nail starter: Helps to start nails in difficult to reach places.

Low weight: Due to the natural wood handle a very lightweight hammer but still incredibly powerful.

Model No.	Weight oz. g	Face (milled or smooth)	Length Inch mm	Id. No. 4932	EAN Code 4002395
① Ti14MC-H18	14 397	M	18" 457	352583	372416
② Ti14SC-H18	14 397	S	18" 457	352584	372423
③ Ti14MC-H16	14 397	M	16" 406	352585	372430
④ Ti14SC-H16	14 397	S	16" 406	352586	372447

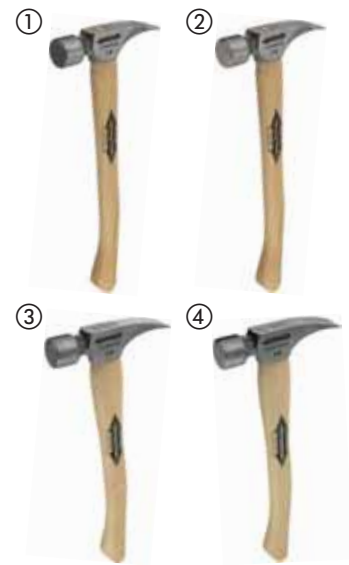

Clawbar nail puller

- 100% titanium construction – 5 times stronger than steel.
- 295 mm long for good leverage.
- Weighs only 225 grams. 50% lighter than steel.
- Two claws.
- Dimpler: when positioned over the nail head and struck with a hammer, it creates a recess around the nail allowing then the claws to slide underneath the head of the nail for easy removal without damaging the surrounding wood.
- "W" Beam structure for less weight and added strength.



Model No.	Weight g	Length mm	Id. No. 4932	EAN Code 4002395
TICLW-12	225	295	352703*	373611

Stainless steel bar SSFB15

- Durable stainless steel construction: rust proof
- Long and compact: for better leverage
- 50% cost advantage over titanium
- Less weight than steel
- Multifunctional: 2 claws – for nail and staples, bottle opener

430089* 377503



Stainless steel bar SSCLW12

- Durable stainless steel construction: rust proof
- Dimpler® prevents damaging wood: pull nail cleanly
- 50% cost advantage over titanium
- Less weight than steel
- 2 nails pullers: angled nail puller – straight nail puller

430088* 377497



Spare parts

Model No.	Description	Id. No. 4931	EAN Code 4002395
① TBM-MR	3oz Steel Milled Replacement Face for TB15MC and TBM14RMC.	428165	835003
② TBM-SR	3oz Steel Smooth Replacement Face for TB15MC and TBM14RMC.	428166	835010
TBR-B	Replacement Bolt kit for TB15MC and TBM14RMC. Contains: 1 x bolt, 1 x washer, 1 x allen key, 1 x loctite tube, 1 x instruction manual.	428167	835027
Handle H18"	18" Hickory replacement curved handle for 14oz heads.	428170	835058
Handle H16"	16" Hickory replacement curved handle for 14oz heads.	428171	835065



* while stocks last

Handtools

FASTBACK™ flip utility knife

- **One handed blade opening:** user can flip open the blade with one hand for easy activation.
- **Integrated gut hook:** allows users to make cuts without exposing the blade.
- **Tool free blade change:** less down time in the field for blade changes.
- **Wire stripper:** eliminates the need to look for another tool in user's bag.
- **Thin body design:** tool is easily stored in user's pocket.
- **Belt clip:** for easy storage.



Description / Application	Quantity	Id. No.	UPC / EAN Code
① FASTBACK™ knife	1	48221901	45242204649
Counter display			
② (contains 6x FASTBACK™ flip utility knife 48221901)	1	4932352622	4002395372805
③ FASTBACK™ knife with blade storage	1	48221902	452422292547

Sliding utility knife

- **Side slide blade activation:** reduces the risk of exposing the blade accidentally.
- **Wire stripper:** eliminates the need for another tool in the users bag.
- **Tool free blade change:** saves time changing blades.
- **Blade storage:** magnetic holder for 5 blades.
- **Heavy Duty:** full metal body with rubber overmould for increased comfort and reduced hand slippage.



Description / Application	Quantity	Id. No.	UPC / EAN Code
Sliding utility knife	1	48221910	45242204625
Counter display			
① (contains 6x sliding utility knife 48221910)	1	4932352626	4002395372843

Self-retracting safety knife

- **Self-retract mechanism:** retracts blade when the button is released.
- **Two blade positions** allows user to control cutting depth.
- **Blade storage** holds up to 5 blades conveniently inside the handle.
- **Tool-free blade change:** saves time changing blades. Thumb-screw mechanism allows user to change the blade quickly and without any extra tools.
- **Heavy Duty:** durable full metal body.
- **Wire stripper:** eliminates the need to look for another tool in user's bag. Cut up the wire up to Ø 5 mm².



Description / Application	Quantity	Id. No.	UPC Code
Self-retracting safety knife	1	48221915	45242 296873

Utility knife blades

- Iron carbide deposited metal for longer lifetime.
- Optimised cutting angle geometry for sharpness.
- Extra ground cutting edge for cleaner cuts.
- Blades are protected and easily accessible from storage box.

Description / Application	Total length mm	Total height mm	Quantity	Id. No.	UPC Code 45242
① General purpose utility knife blades	62	19	50	48221950	344444
② Hook utility knife blades	62	19	50	48221952	286980
③ Carton utility knife blades (rounded tip)	62	19	5	48221934	286942



Rasping jab saw

- **150 mm plaster/drywall blade:** extra strong thicker blade making it more resistant for plunge cuts.
- Coated for corrosion protection.
- **Rubber overmould:** increased comfort and reduced hand slippage.
- **Built in rasping holes:** allows user to rapidly expand holes or smooth rough edges.



Description / Application	Quantity	Id. No.	UPC / EAN Code
Rasping jab saw	1	48220304	45242204595
① Counter display (contains 6x rasping jab saw 48220304)	1	4932352662	4002395373208



Snap knives

- **Metal lock*** for maximum durability and longer lifetime.
- **Lock with a speed thread*** that allows faster blade adjustment.
- **Auto-lock slide**** for faster blade adjustment.
- **Snap-off cap pocket clip**** snaps off blade segments.
- **Overmolded handle** offers a slip resistant grip and is an acetone resistant.
- **Iron carbide blade** for longer lifetime, increased sharpness and clean cut finish.

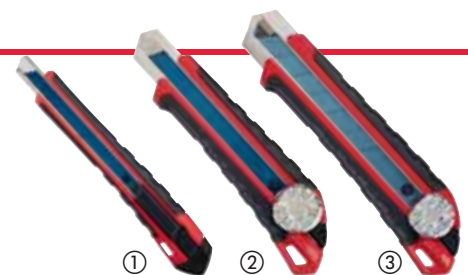

Description / Application	Blade width mm	Number of blade points	Quantity	Id. No.	UPC Code 45242
① Snap knife	9	13	1	48221960	296811
② Snap knife	18	8	1	48221961	296798
③ Snap knife	25	7	1	48221962	296828

*18 mm/25 mm snap knives **9 mm snap knives

Snap blades

- **Robust re-usable storage dispenser** with easy access to blades.
- **Optimized cutting angle geometry** for sharpness and improved cutting precision.
- **Iron carbide metal** for longer life.
- **Precise ground cutting edges** for cleaner cuts.

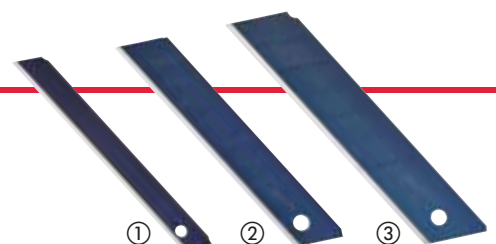

Description / Application	Blade width mm	Number of blade points	Quantity	Id. No.	UPC Code 45242
① Snap blades	9	13	10	48229109	288649
② Snap blades	18	8	10	48229118	288656
③ Snap blades	25	7	10	48229125	288663

Metal snips

- Thumb and forefinger slots for increased comfort and less fatigue. Allows user to push through sheet metal with ease with less risk of cutting oneself.
- Serrated cutting edges prevent slippage when cutting.
- Less hand fatigue when cutting thicker materials. Design with compound leverage action.
- Torsion spring opens jaws automatic during cutting for faster cutting action and less fatigue work.
- Chrome plated rust protected forged blades for increased lifetime. Extra hardened to 65 HRC.
- One hand locking mechanism.
- Flush slimline design for non-snagging in material.
- Triple cutting direction identification – on the head, handle and by colour coded handle.
- Ergonomic and durable overmoulded grips add comfort and last longer.



① **Aviation snips:** for short, straight and shaped cuts. Ideal for narrow radius cuts and notch cuts.

Cutting direction	Total length mm	Edge length mm	Cutting capacities		Weight g	Id. No.	UPC Code 45242
			Steel, alu, copper thickness max. mm	Stainless steel thickness mm			
Straight (yellow)	260	31	1.0	0.6	430	48224030	251339
Right (green)	260	31	1.0	0.6	430	48224020	251315
Left (red)	260	31	1.0	0.6	430	48224010	251292

② **Offset snips:** for long continuous straight or curved cuts. 45° offset keeps users hand away from the cutting material.

Straight (yellow)	260	37	1.0	0.6	430	48224032	288144
Right (green)	260	30	1.0	0.6	430	48224022	288120
Left (red)	260	30	1.0	0.6	430	48224012	288137

③ **Extra long aviation snips:** for longer and straighter cuts in one go.

Straight (yellow)	310	76	1.0	0.6	450	48224037	332083
Left (offset)	290	63	1.0	0.6	450	48224038	332090

Long nose pliers with wire stripper - 6 in 1 tool

- **Long nose pliers:** specially suitable for gripping, bending and adjusting in restricted areas.
- **Wire stripper:** strips 3 sizes of wire: 0,5–0,75/1,5/2,5 mm².
- **Wire cutter:** cuts wire up to 2.8 mm.
- **Deburrer:** deburring ribs on head for up to 25 mm pipe. No need for extra tools.
- **Nail puller**
- **Loop maker:** built in loop maker function for wire up to 6.6 mm²/Ø 2.9 mm.
- Crosswise serrated jaws for better grip and excellent control.
- Laser hardened durable cutting edges. Extra hardened to 64 HRC.
- Made from Chrome Vanadium for best durability and good rust protection.
- Ergonomic and durable overmoulded grips add comfort and last longer.



Stripping capacities mm ²	Cutting capacities		Total length mm	Jaw thickness mm	Weight g	Deburring max. Ø mm	Id. No.	UPC Code 45242
	Medium/hard wire Ø mm	Cable Ø mm						
0.5–0.75/1.5/2.5	2.8	13.0	200	13.5	320	25	48229068	271269

Combination pliers with wire stripper - 6 in 1 tool



- **Pliers:** specially suitable for gripping, bending and adjusting in restricted areas.
- **Wire stripper:** strips 5 sizes of wire: 0,5–0,75/1,0/1,5/2,5/4,0 mm².
- **Wire cutter:** cuts wire up to 2.5 mm.
- **Deburrer:** deburring ribs on head for up to 25 mm pipe. No need for extra tools.
- **Bolt cutter:** cuts M3 and M4 size threaded bolts.
- **Loop maker:** built in loop maker function for wire up to 6.6 mm²/Ø 2.9 mm.
- Crosswise serrated jaws for better grip and excellent control.
- Laser hardened durable cutting edges. Extra hardened to 50 HRC.
- Made from Chrome Vanadium steel for best durability and good rust protection.
- Slim nose design to reach restricted areas.
- Ergonomic and durable overmoulded grips add comfort and last longer.
- One handed locking mechanism, tool remains tool while in pouch, spring loaded but easy opening.



Stripping capacities mm ²	Cutting capacities		Dimensions		Weight g	Deburring Ø mm	Id. No.	UPC Code 45242
	Medium / Hard wire Ø mm	Cable Ø mm	Total length mm	Jaw thickness mm				
0.5–0.75/1.0/1.5 / 2.5 / 4.0	2.5	6.0	190	4	270	25	48229069	271252

Heavy Duty Lineman's pliers

- For universal gripping, cutting applications.
- **High leverage design:** long handles for maximum cutting power and leverage.
- **Deburrer:** deburring ribs on head for up to 25 mm pipe. No need for extra tools.
- **Nail puller:** powerful gripping and high leverage.
- Laser hardened durable cutting edges: cuts wire, bolts, screws and nails. Extra hardened jaws to 64 HRC.
- Serrated gripping zone for strong gripping and pulling.
- Made from Chrome Vanadium steel for best durability and good rust protection.
- Ergonomic and durable overmoulded grips add comfort and last longer.



Cutting capacities		Total length mm	Weight g	Deburring Ø mm	Id. No.	UPC Code 45242
Medium / hard wire Ø mm	Soft wire Ø mm					
3.0	4.6	250	500	25	48223309	251278

Diagonal pliers

- For all around cutting use.
- **Tip protection:** tips are off set ground to protect cutting edges from damage when dropped.
- **High leverage design:** long handles for maximum cutting power and leverage.
- **Deburrer:** deburring ribs on head for up to 25 mm pipe. No need for extra tools.
- **15° offset head** allows flush cutting, can be used as a nail puller for easier and quicker prying and pulling.
- Laser hardened durable cutting edges. Extra hardened to 64 HRC. Cuts wire, bolts, screws and nails.
- Made from forged alloy Chrome Vanadium steel for best durability and good rust protection.
- Ergonomic and durable overmoulded grips add comfort and last longer.



Total length mm	Cutting capacities		Jaw length mm	Weight g	Id. No.	UPC Code 45242
	Medium/hard wire Ø mm	Soft wire Ø mm				
160	2.5	4.0	22	230	48224106	251360
180	3.0	4.0	26	290	48224107	251353

Quick adjust water pump pliers

- For gripping, fastening and holding work pieces.
- One hand push button adjustment for fast and firm grip.
- Fine scale adjustment positions for precise grip. Less downtime and more efficiency.
- Self locking button for fast and firm adjustment.
- V-groove jaws with profile for firmer grip, more precise fit and reduced slipping. Special teeth hardening 60 HRC.
- Made from Nickel and Chrome forged alloy steel for best durability and good rust protection.
- Ergonomic and durable overmoulded grips add comfort and last longer.
- Deburring head and handle design. No need for extra tools.
- Available in 3 lengths for optimum leverage.



Total length mm	Total length inch	Nut size mm AF (Across flats)	Tubes/pipes Ø mm	Weight g	Deburring head max. Ø mm	Deburring handles max. Ø mm	Id. No.	UPC Code 45242
200	8	30	32	270	38	25	48223108	251247
250	10	36	42	450	51	25	48223110	251230
300	12	50	60	800	70	25	48223112	251223

TORQUE LOCK™ locking pliers

NEW

- **TORQUE LOCK™:** Faster set up and easy release when clamping flat and round material. Extra force can be applied to the TORQUE LOCK™ screw for better and more secure grip. Can also be used for hanging/storage purposes.
- **Hardened jaws:** better grip force on jobsite material.
- **Rust protection:** chrome plated tool increases life by reducing corrosion.
- **Control release design:** fast and easy one-hand release.

	Total length mm	Total length inch	Jaw type	Jaw capacity flat mm	Jaw capacity pipe mm	Id. No.	UPC/EAN Code 45242
①	250	10	curved	–	51	48223420	325276
②	250	10	flat	30	–	48223510	324996
③	150	6	flat long nose	61	–	48223406	325030



TORQUE LOCK™ locking C clamps

NEW

- **TORQUE LOCK™:** Faster set up and easy release when clamping flat and round materials for welding. Extra force can be applied to the TORQUE LOCK™ screw for better and more secure grip. Can also be used for hanging/storage purposes.
- **Hardened jaws:** better grip force on jobsite material.
- **Rust protection:** chrome plated tool increases life by reducing corrosion.
- **Control release design:** fast and easy one-hand release.

	Total length mm	Total length inch	Jaw type	Jaw capacity mm	Id. No.	UPC/EAN Code 45242
①	280	11	swivel pads	100	48223521	325054
②	280	11	regular pointed	90	48223531	325115



STOP LOCK™ hand clamps*

NEW

- **STOP LOCK™:** Single handed clamp. Maximum holding force in one pressing.
- **Overmould grip:** maximum grip for comfort and performance.
- **Optimised pad design:** secure swivel pads for clamping on a variety of jobsite work surfaces.

	Total length mm	Total length inch	Jaw capacity mm	Pack quantity	Order quantity	Id. No.	UPC/EAN Code 45242
①	200	8	50	12	12	48223022	348039
②	240	9½	100	12	12	48223024	348046



* Minimum order quantity = 12 pcs (supplied in counter display).
Order > 12 pcs must be ordered in multiples of 12 pcs (i.e. 12, 24, 36...).

Jobsite scissors

NEW

- **Iron carbide cutting edge** for maximum durability. Longer lifetime vs. stainless steel.
- **Chrome plated blades** for maximum rust protection.
- **All metal core:** full metal handle construction to protect from drops and handle breakage.
- **Bolt lock technology** protects blades from loosening to ensure precise cutting.
- **Large handle loops** for use with gloves.
- **Index finger groove** for more comfort.
- **Laser edged ruler markings** on the blade allows to measure and cut in one go.
- **Jobsite offset scissors** with micro-serrated blades for maximum durability and better grip.
- **Jobsite offset scissors with 60°-offset head** allows to keep hand above cutting material.

Description	Total length mm	Blade length mm	Weight g	Pack quantity	Order quantity	Id. No.	UPC Code 45242
① Jobsite straight scissors	230	95	180	1	1	48224044	347483
② Jobsite offset scissors	240	115	230	1	1	48224043	347476



Plastic cutter

- Cuts PEX, PB, MDP, PE, plastic electrical conduits, pneumatic pipe, plastic overflow pipe, rubber hoses, silicon hoses up to Ø 25 mm.
- V-shaped blade allows quick and straight cuts; prevents crushing of material.
- Replaceable stainless steel blade.
- Robust construction – metal core from the head to the handles for maximum lifetime. Corrosion resistant head.
- Grooves on the head allows stripping of couplings.
- One handed locking mechanism, tool remains closed while in pouch, spring loaded but easy opening.
- Ergonomic and durable overmoulded grips add comfort and last longer.

Description	Cutting capacities Tubes/pipes Ø mm	Id. No.	UPC Code 45242
Plastic cutter	25	48224200*	251377
Plastic cutter	25	48224202	341333

Description	48224200	48224202	Id. No.	UPC Code 45242
Replaceable blade	✓	X	48224201*	268085
Replaceable blade	✓	✓	48224203	343140



Tape measures



- **Double sided nylon bond blade protection** for extreme tape durability against dust, dirt, debris and water.
- **Non reflective blade coating** makes the tape anti-glare and easier to read in bright sunlight.
- **Finger stop** for comfortable hold and finger protection when the blade retracts.
- **Dual magnets:** one magnet holds the hook in front; a second magnet prevents roll off on the material e.g. on steel studs, pipes.
- **2-sided scale printing:** horizontal measuring scale on the front side; vertical measuring scale on back side for increased readability.
- **Premium quality** with 27 mm blade width.
- **5-point reinforced frame** for job site durability.
- **Wire belt clip:** clips on easily without fraying and tearing clothing.
- **Extra large 360° grip hook:** can be hooked on the material from any side with ease.
- **Architect scale:** is integrated for easy calculating of scaled drawings (ISO 5455). Enables to measure distances and calculate material demand directly on construction site.
 5 m & 8 m tape measures: 1:20 and 1:50 scales
 5 m / 16 ft & 8 m / 26 ft tape measures: 1/8" to 1" and 1/4" to 1" scales
- **Overmould gripping area** for extra comfort and durability.
- **Class II accuracy**

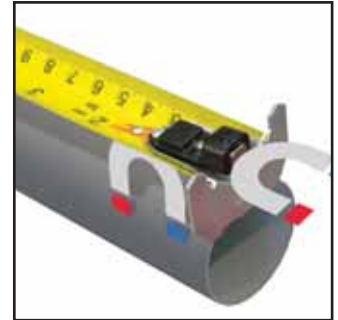

Dual magnet



Reinforced housing with 5 screws



Finger stop



Double sided marked blade

Description	Length	Pack quantity	Order quantity	Id. No.	UPC Code 45242
Metric	5 m	6	6	48225305	317677
Metric	8 m	6	6	48225308	317684
Metric	10 m	6	6	48225411	347421
Metric & Imperial	5 m / 16"	6	6	48225216	296903
Metric & Imperial	8 m / 26"	6	6	48225225	296910
Metric & Imperial	10 m / 33"	6	6	48225233	317707

Orders are only possible in master cartons (contains 6x 48225305).
 Minimum order quantity is 6x 48225305 (= 1 master carton).
 Order quantities greater than 6 pcs are to be ordered in multiples of 6 pcs (i.e. 12, 18, 24, 30...).



6 pcs master carton

Tape measures - Contractor series

NEW



- **Double sided nylon bond blade protection** for extreme tape durability against dust, dirt, debris and water.
- **Non reflective blade coating** makes the tape anti-glare and easier to read in bright sunlight.
- **Extra wide base 41 mm.**
- **Premium quality** with 27 mm blade width.
- **5-point reinforced frame** for job site durability.
- **Wire belt clip:** clips on easily without fraying and tearing clothing.
- **Extra large 360° grip hook:** can be hooked on the material from any side with ease.
- **Overmould gripping area** for extra comfort and durability.
- **Class II accuracy.**

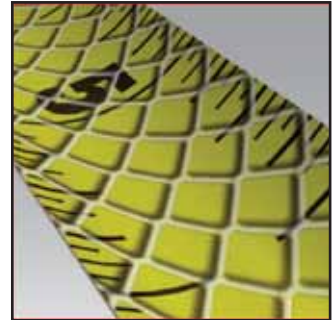

Nylon bond blade protection



Reinforced housing with 5 screws



Wide base

Description	Length	Pack quantity	Order quantity	Id. No.	UPC Code 45242
Metric	5 m	6	6	48225705	350551
Metric	8 m	6	6	48225708	350568
Metric & Imperial	5 m / 16"	6	6	48225616	350575
Metric & Imperial	8 m / 26"	6	6	48225625	350582

Orders are only possible in master cartons.
 Minimum order quantity is 6 pieces.
 Order quantities greater than 6 pcs are to be ordered in multiples of 6 pcs (i.e. 12, 18, 24, 30...).



6 pcs master carton

INKZALL™ markers

NEW

INKZALL™ jobsite markers feature clog resistant tips and the ability to write through dusty, wet or oily surfaces.

- **Durable acrylic nib** is ideal for rough surfaces as OSB, concrete. Also suitable for marking on wood, metal, plastic and ceramics.
- **Acrylic nib** stays sharp longer, doesn't mushroom or push back under pressure
- **Ink dries quickly** to reduce smearing. However the INKZALL™ markers don't dry out quickly when the cap is left off.
- **Anti-Roll body design** for better grip on smooth surfaces.
- **Construction helmet clip:** the INKZALL™ markers can be clipped to the helmet, trousers, overalls, etc.
- **Lanyard hole,** e.g. to attach the INKZALL™ markers to the belt; stylus INKZALL™ marker to a touch screen device.
- **Non-toxic ink,** ASTM D 4236 certification.
- **INKZALL™ fine tip with stylus - the first marker with the stylus function on the market!**



① Fine tip



② Fine tip with stylus



③ Chisel tip



④ Coloured markers

Description	Tip	Pack quantity	Order quantity	Id. No.	UPC Code 45242
① Fine tip*	1 mm	36	36	48223100	319473
② Fine tip with stylus	1 mm	1	1	48223101	297436
③ Chisel tip	1–4.8 mm	1	1	48223103	333608
Coloured markers					
④ Pack of 4 fine tip markers. Blue, red, green and black.	1 mm	4	1	48223106	333585

* Orders are only possible in master cartons (contains 36x 48223100).
 Minimum order quantity is 36 pcs (= 1 master carton).
 Order quantities greater than 36 pcs are to be ordered in multiples of 36 pcs (i.e. 72, 108, 144, 180...).

Jobsite work box

NEW

- **Jobsite durability**
Survives 1000 drops.
Reinforced corners.
Buttressed hinges.
Protected recessed latches.
Integrated weather seal protects contents from rain and debris.
- **Storage**
Removable tray.
Corner pocket dividers to keep tools organised and easily accessible.
Large capacity for long and bulky tools.
- **Wide center soft grip handle**, plus two side handles for easy carrying.
- **V groove** on top lid for pipe cutting.
- **Indexing squares** for secure stacking.
- **Removable tray.**
- **Screw bosses** on inside lid for unlimited customisation.



Description	Length mm	Width mm	Height mm	Pack quantity	Order quantity	Id. No. 4932	EAN Code 4002395
Jobsite work box	670	350	310	1	1	430826	384884

Electricians pouch

NEW

- **Robust construction:** made from 1680D ballistic nylon. Tough and thick quality. Double stitched, riveted seams.
- **Integrated handle:** allows easy transport. Provides an easy mounting point on common jobsite materials.
- **Solid base:** allows bag to stand up, even when fully loaded.
- **Integrated belt loops:** allows bag to be worn on a tool belt.
- **Center-mounted metal D-rings:** allows bag to hang evenly from shoulder strap.
- **Metal tape measure clip:** securely stores tape for easy access.



Description	Pack quantity	Order quantity	Id. No.	UPC Code 45242
Electricians pouch	1	1	48228100	333929

Zipper pouches

NEW

- **Heavy duty zipper pouches (3pcs pack):** durable – made from heavy duty canvas to withstand jobsite abuse.
- **Water resistant stand up base:** allows bags to stand up for easy viewing of contents. Protects contents from water damage.
- **Webbing loop:** allows bags to be hooked together or to a bag.



Description	Pack quantity	Order quantity	Id. No.	UPC Code 45242
Zipper pouches (3pcs pack)	3	1	48228193	344611

Electricians belt

NEW

- **Robust construction:** made from 1680D ballistic nylon. Tough and thick quality. Double stitched, riveted seams.
- **Integrated handles:** allows easy transport of pouch. Provides easy mounting point on common jobsite materials.
- **Padded, breathable belt:** ultimate comfort and jobsite performance.
- **Metal suspender attachments:** allows suspenders to be added.
- **Metal tape measure clip:** securely stores tape for easy access.



Description	Pack quantity	Order quantity	Id. No.	UPC Code 45242
Electricians belt	1	1	48228110	333936

Contractor rig

NEW

- **Robust construction:** made from 1680D ballistic nylon. Tough and thick quality. Double stitched, riveted seams.
- **Padded 4-point harness:** distributes weight for all day comfort.
- **Padded, breathable belt:** ultimate comfort and jobsite performance.
- **Large storage capacity:** 2 separate pouches, smart phone pocket and hammer holder.



Description	Pack quantity	Order quantity	Id. No.	UPC Code 45242
Contractor rig	1	1	48228120	333974

Jobsite backpack

NEW

- **Durability:** made from 1680D ballistic nylon. Tough and thick quality. Hard moulded base allows bag to stand up and provides ultimate all-weather protection.
- **Fold-down front pocket:** large storage – 35 pockets in total. Fold down front pocket for easier access and storage of larger items. Side water bottle pocket.
- **Padded, breathable straps:** ultimate comfort and jobsite performance.
- **Vertical tool wall:** maximizes storage space while allowing for bulk storage space.
- **Laptop pocket:** allows protected storage for laptops/tablets and personal goods.
- **Exterior daisy chains:** allows clip on storage.



Description	Pack quantity	Order quantity	Id. No.	UPC Code 45242
Jobsite backpack	1	1	48228200	333943



Nothing but **HEAVY DUTY.**[™]

Techtronic Industries ELC GmbH

Postfach 320
D-71361 Winnenden
Germany
Tel. +49 7195 12 0
Fax +49 7195 666

Distributed by: